

R-410A Outdoor Split-System Heat Pump Installation Manual - YH2E / THE2 / RHP143 Series

York International Corporation, 5005
York Drive, Norman, OK 73069

6198123-UIM-A-0622
Supersedes: nothing

2022-02-23

Contents

General.....	5	Demand defrost.....	36
Safety.....	5	Operation.....	36
Inspection.....	5	Defrost curves.....	36
Requirements for installing/servicing R-410A equipment.....	5	Defrost curve selection.....	36
Limitations.....	5	Defrost cycle initiation.....	36
Unit installation.....	6	Defrost inhibition.....	36
Location.....	6	Defrost termination.....	37
Add-on replacement/retrofit.....	6	Cooling operation.....	37
Ground installation.....	8	Heating operation.....	37
Roof installation.....	8	Emergency heat.....	37
Wall mount installation.....	8	Pressure switch fault and lockout.....	37
Unit placement.....	9	Instructing the owner.....	37
Liquid line filter-drier.....	9	Maintenance.....	38
Piping connections.....	9	Wiring diagrams.....	39
Precautions during line installation.....	10	Start-up sheet.....	42
Precautions during brazing of lines.....	10		
Precautions during brazing of service valve.....	10		
Connecting the refrigerant lines.....	11		
Indoor expansion device.....	12		
Thermostatic expansion valve (TXV) installation.....	12		
Evacuation.....	13		
System charge.....	13		
Measuring indoor airflow.....	14		
Charging the unit.....	14		
Determining the total system charge.....	14		
Charging with gauges.....	15		
Subcooling charging charts.....	15		
Heating charging charts.....	21		
Electrical connections.....	27		
General information and grounding.....	27		
Field connections power wiring.....	28		
Field connections control wiring.....	28		
Control wiring diagrams.....	30		
Dehumidification control (typical).....	32		
Indoor cubic feet per minute (CFM) settings (typical).....	32		
System start-up.....	33		
Energize crankcase heater (where applicable).....	33		
System operation.....	33		
Anti short-cycle delay.....	33		
Low voltage detection.....	33		
Test input.....	33		
Fault code display.....	35		

General

The outdoor units are designed to be connected to a matching indoor coil with sweat connect lines. Sweat connect units are factory charged with refrigerant for a nominal sized matching indoor coil plus 15 ft of field-supplied lines.

Matching indoor coils can be used with a thermostatic expansion valve (TXV). Refer to the *Tabular Data Sheet* or to the *Technical Guide* for the proper selection.

Safety



This is a safety alert symbol. When you see this symbol on labels or in manuals, be alert to the potential for personal injury.

Understand and pay particular attention to the signal words **DANGER**, **WARNING**, or **CAUTION**.

DANGER indicates an **imminently** hazardous situation, which, if not avoided, **will result in death or serious injury**.

WARNING indicates a **potentially** hazardous situation, which, if not avoided, **could result in death or serious injury**.

CAUTION indicates a **potentially** hazardous situation, which, if not avoided **may result in minor or moderate injury**. It is also used to alert against unsafe practices and hazards involving only property damage.

WARNING

Improper installation may create a condition where the operation of the product could cause personal injury or property damage. Improper installation, adjustment, alteration, service, or maintenance can cause injury or property damage. Refer to this manual for assistance. For additional information, consult a qualified contractor, installer, or service agency.

CAUTION

This product must be installed in strict compliance with the enclosed installation instructions and any applicable local, state, and national codes including but not limited to building, electrical, and mechanical codes.

CAUTION

R-410A systems operate at higher pressures than R-22 systems. Do not use R-22 service equipment or components on R-410A equipment. Service equipment must be rated for R-410A.

Inspection

As soon as a unit is received, it must be inspected for possible damage during transit. If damage is evident, the extent of the damage must be noted on the carrier's delivery receipt. A separate request for inspection by the carrier's agent must be made in writing. See Local Distributor for more information.

Requirements for installing/servicing R-410A equipment

- Gauge sets, hoses, refrigerant containers, and recovery system must be designed to handle the POE type oils, and the higher pressures of R-410A.
- Manifold sets should be high side and low side with low side retard.
- All hoses must have a 700 psig service pressure rating.
- Leak detectors should be designed to detect HFC refrigerant.
- Recovery equipment (including refrigerant recovery containers) must be specifically designed to handle R-410A.
- Do not use an R-22 TXV.

Limitations

The unit must be installed in accordance with all National, State and Local Safety Codes and the limitations listed below:

- Limitations for the indoor unit, coil, and appropriate accessories must also be observed.
- The outdoor unit must not be installed with any duct work in the air stream. The outdoor fan is the propeller type and is not designed to operate against any additional external static pressure.
- The maximum and minimum conditions for operation must be observed to ensure a system that will give maximum performance and service life.

Table 1: Maximum/minimum operating limit conditions

Air temperature at outdoor coil °F				Air temperature at indoor coil °F			
Minimum		Maximum		Minimum		Maximum	
DB cool	DB heat	DB cool	DB heat	WB cool	DB heat	WB cool	DB heat
55	0	125	75	57	50	72	80

Note:

- Operation below this temperature is permissible for a short period of time, during morning warm-up.
- The unit should not be operated in cooling mode at outdoor temperatures below 50°F without an approved low ambient operation accessory kit installed.
- The maximum allowable line length for this product is 80 ft. Consult the Piping Application Guide (P/N 247077) for installations over the maximum allowable line length. Installation of an accessory crankcase heater is required if not factory installed for installations over the maximum allowable line length.

Unit installation

Location

Before starting the installation, select and check the suitability of the location for both the indoor and outdoor unit. Observe all limitations and clearance requirements.

The outdoor unit must have sufficient clearance for air entrance to the outdoor coil, air discharge, and service access. See Figure 1 and Figure 2.



NOTICE

For multiple unit installations, units must be spaced a minimum of 24 in. (61 cm) apart (coil face to coil face).

If the unit is installed on a hot sun-exposed roof or a paved ground area that is seasonally hot, the unit must be raised sufficiently above the roof or ground to avoid taking the accumulated layer of hot air into the outdoor unit.

If the system is being installed during seasonally cold weather of 55°F or below, the preferred method is to weigh in the charge. For charging or checking the system charge at 55°F or below, see [Heating charging charts](#). There is an Optional Cold Weather Charging accessory kit to prevent the outdoor unit from taking in cold air

below 55°F. The kit part number can be found in the list of accessory kits at www.simplygettingthejobdone.com.

Provide adequate structural support for the unit.

Add-on replacement/retrofit

About this task:

When using this unit as a replacement for an R-410A unit, you must replace the outdoor unit, indoor coil, and metering device. Do the following to ensure proper system operation and performance. Change out the line set where possible.

1. Change out the indoor coil to an approved R-410A coil or outdoor unit combination with the appropriate metering device.
2. Change out the line-set when replacing an R-22 unit with an R410-A unit to reduce cross-contamination of oils and refrigerants.
3. If a change out of the line set is not practical, then the following precautions should be taken.
 - Inspect the line set for kinks, sharp bends, or other restrictions, and for corrosion.
 - Determine if there are any low spots which might be serving as oil traps.
 - Flush the line set with a commercially available flush kit to remove as much of the existing oil and contaminants as possible.
 - Install a suction line filter-drier to trap any remaining contaminants, and remove after 50 h of operation.
4. If the outdoor unit is being replaced due to a compressor burnout, then installation of a 100% activated alumina suction-line filter drier in the suction-line is required, in addition to the factory installed biflow liquid-line drier. Operate the system for 10 h. Monitor the suction drier pressure drop. If the pressure drop exceeds 3 psig, replace both the suction-line and liquid-line driers. After a total of 10 h runtime where the suction-line pressure drop has not exceeded 3 psig, replace the liquid line drier, and remove the suction-line drier. Never leave a suction-line drier in the system longer than 50 h of run time.

Example:

Figure 1: Typical installation clearances

▲ CAUTION: Special care must be taken to avoid recirculation of discharge air through outdoor coil.

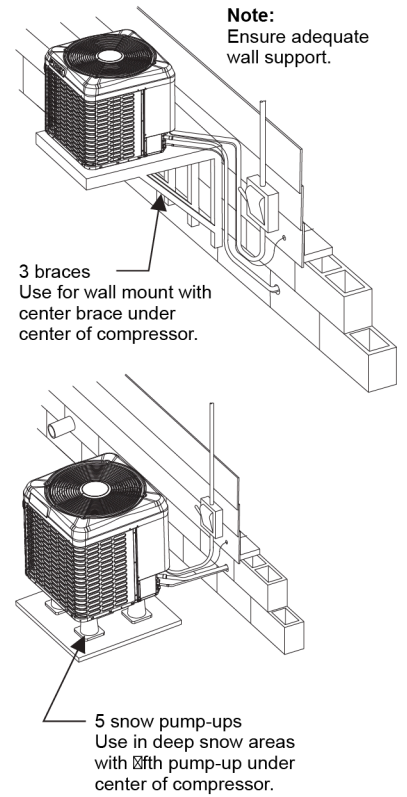
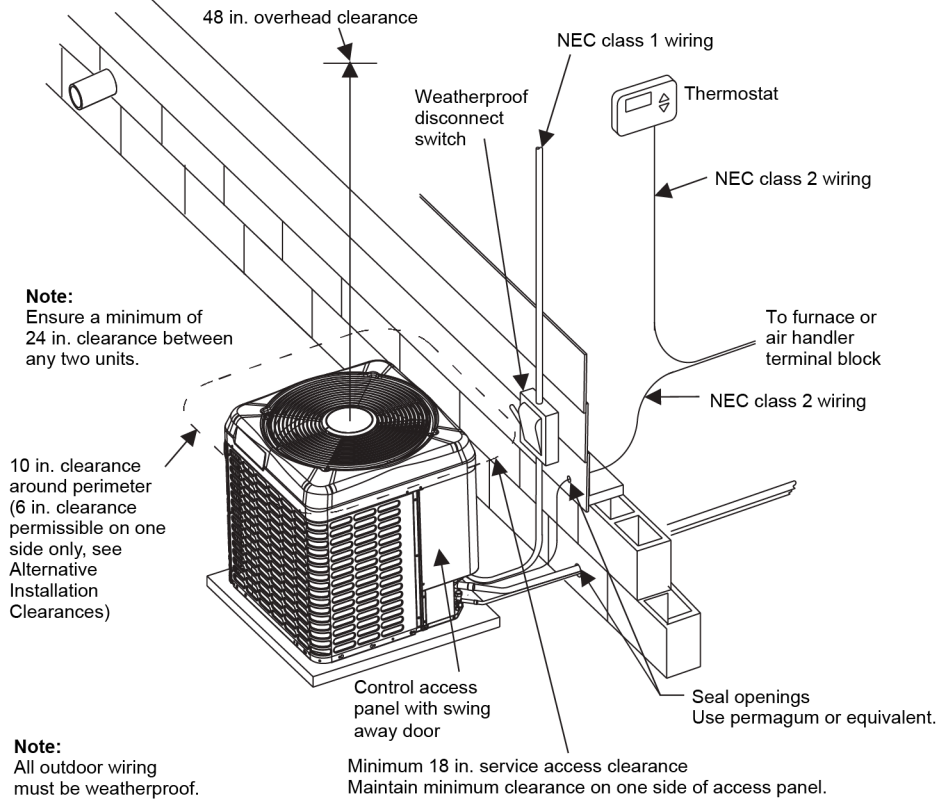

A0260-002

Figure 2: Alternative installation clearances

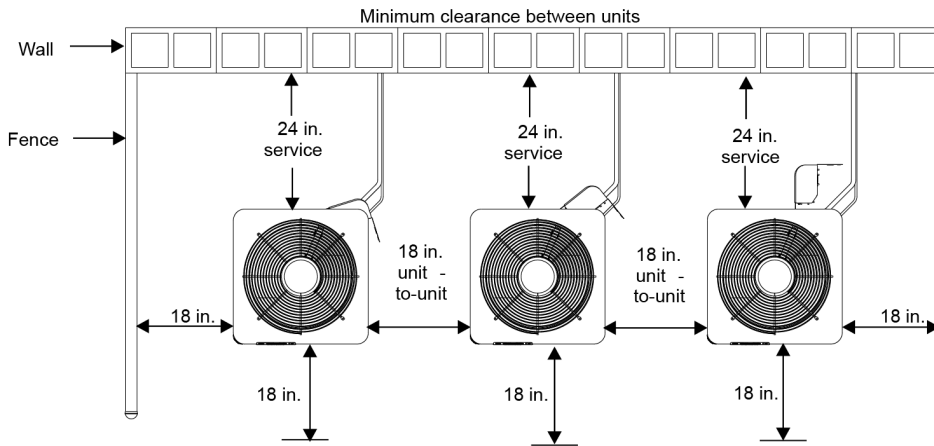

Note:
Clearance between two units may be reduced to 18 in. minimum provided the service access clearance is increased to 24 in. minimum, and the clearance on each remaining side is maintained at 18 in. minimum.

Note:
Clearance to one side of the unit may be reduced to 6 in. provided the clearance to each remaining side is increased to 12 in. minimum, the service access is increased to 24 in. minimum, and the clearances between any two units is maintained at 24 in. minimum.

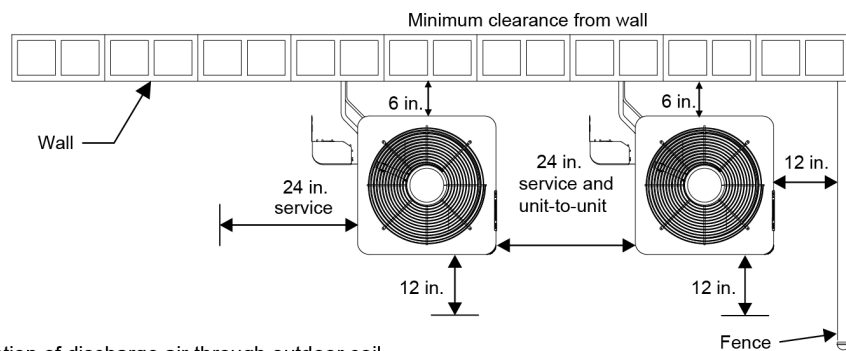

CAUTION:
Special care must be taken to avoid recirculation of discharge air through outdoor coil.

A0287-001

Ground installation

The unit may be installed at ground level on a solid base that will not shift or settle, causing strain on the refrigerant lines and possible leaks. The unit must be installed in as level a position as possible while maintaining the clearances shown in Figure 1 and Figure 2.

Normal operating sound levels may be objectionable if the unit is placed directly under windows of certain rooms such as a bedroom or study.

Condensate will drain from beneath the coil of the outdoor unit during the defrost cycle. Normally this condensate may be allowed to drain directly on the ground.

WARNING

The outdoor unit must not be installed in an area where mud or ice could cause personal injury. Remember that condensate will drip from the unit coil during heat and defrost cycles and that this condensate will freeze when the temperature of the outdoor air is below 32°F.

Elevate the unit sufficiently to prevent any blockage of the air entrances by snow in areas where there will be snow

accumulation. Check the local weather bureau for the expected snow accumulation in your area.

Isolate the unit from rain gutters to avoid any possible wash out of the foundation.

Roof installation

When installing units on a roof, the structure must be capable of supporting the total weight of the unit, including a pad, lintels, and rails, which should be used to minimize the transmission of sound or vibration into the conditioned space.

Wall mount installation

Care must be taken to mount the outdoor unit on a solid base that is sloped to shed water, secure from settlement, and is isolated from the structural foundation or walls to prevent sound and vibration transmission into the living space.

On occasion, site conditions may require direct wall mounted brackets to be used to locate and support the outdoor unit. In these applications, care must be taken to address unit base pan support, structural integrity, safe access and serviceability, as well as the possible sound and vibration transmission into the structure. These applications are best served by a properly engineered solution.

Unit placement

About this task:

NOTICE

Heat pumps will defrost periodically resulting in water drainage. The unit must not be located where water drainage may freeze and create a hazardous condition - such as sidewalks and steps.

1. Provide a base in the pre-determined location.
2. Remove the shipping carton and inspect for possible damage.
3. Ensure that compressor tie-down bolts remain tightened.
4. Position the unit on the base provided.

Liquid line filter-drier

The filter-drier is packaged and shipped along with the outdoor unit. It is located outside the unit next to the service valves.

CAUTION

Filter-drier is required to be installed in liquid line. The recommended location is at the indoor coil before the refrigerant metering device. It can be installed at the outdoor unit if desired.

CAUTION

Using a granular type drier may result in damage to the equipment.

CAUTION

Filter-drier must be wrapped in wet rag while brazing.

NOTICE

Replacements for the liquid line drier must be bi-flow and an approved replacement from Source 1.

R-410A filter-drier source 1 Part Number	Apply with models
S1-404101	All heat pumps

Piping connections

The outdoor unit must be connected to the indoor coil using field supplied refrigerant grade (ACR) copper tubing that is internally clean and dry. Units should be installed only with the tubing sizes for approved system combinations as specified in tabular data sheet. The charge given is applicable for total tubing lengths up to 15 ft (4.6 m). See Piping Application Guide (P/N 247077) for installing tubing of longer lengths and elevation differences.

NOTICE

Using a larger than specified line size could result in oil return problems. Using too small a line will result in loss of capacity and other problems caused by insufficient refrigerant flow. Slope horizontal vapor lines at least 1 in. (2.5 cm) every 20 ft (6.1 m) toward the outdoor unit to facilitate proper oil return. If more than the 80 ft line length is necessary, facilitate proper refrigerant velocity with adjusted line diameter in accordance with the Piping Application Guide (P/N 247077).

CAUTION

This system uses R-410A refrigerant which operates at higher pressures than R-22. No other refrigerant may be used in this system. Gauge sets, hoses, refrigerant containers, and recovery system must be designed to handle R-410A. If you are unsure, consult the equipment manufacturer.

WARNING

Never install a suction-line filter drier in the liquid line of an R-410A system. Failure to follow this warning can cause a fire, injury or death.

Precautions during line installation

- Install the lines with as few bends as possible. Care must be taken not to damage the couplings or kink the tubing. Use clean hard drawn copper tubing where no appreciable amount of bending around obstruction is necessary. If soft copper must be used, care must be taken to avoid sharp bends which may cause a restriction.
- The lines should be installed so that they will not obstruct service access to the coil, air handling system, or filter.
- Care must also be taken to isolate the refrigerant lines to minimize noise transmission from the equipment to the structure.
- The vapor line must be insulated with a minimum of 1/2 in. foam rubber insulation (Armaflex or equivalent). Liquid lines that will be exposed to direct sunlight, high temperatures, or excessive humidity must also be insulated.
- Tape and suspend the refrigerant lines as shown. Do not allow tube metal-to-metal contact. See Figure 3.
- Use PVC piping as a conduit for all underground installations as shown in Figure 4. Buried lines should be kept as short as possible to minimize the build up of liquid refrigerant in the vapor line during long periods of shutdown.

Figure 3: Installation of vapor line

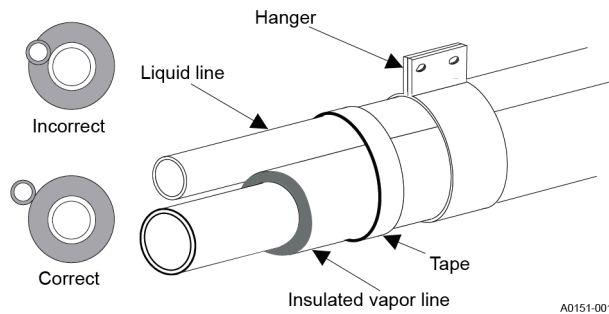

- Pack fiberglass insulation and a sealing material such as permagum around refrigerant lines where they penetrate a wall to reduce vibration and to retain some flexibility.
- For systems with total line length exceeding 80 ft (22.86 m), refer to *Piping Application Guide* (P/N 247077) for vapor and liquid line sizing, calibration of liquid line pressure loss or gain, determination of vapor line velocity, elevation limitations, TXV connections, system charging, traps, and crankcase heater.

Figure 4: Underground installation

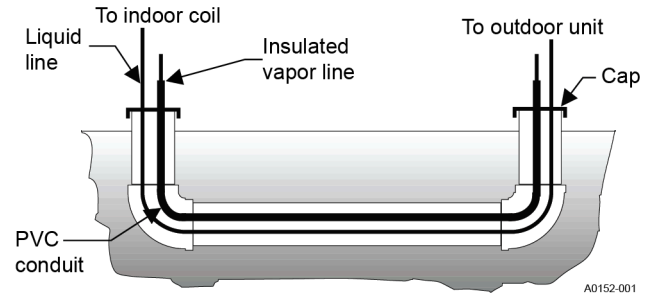

Precautions during brazing of lines

All outdoor unit and indoor coil connections are copper-to-copper and should be brazed with a phosphorous-copper alloy material such as Silfos-5 or equivalent. Do not use soft solder. The outdoor units have reusable service valves on both the liquid and vapor connections. The total system refrigerant charge is retained within the outdoor unit during shipping and installation. The reusable service valves are provided to evacuate and charge per this instruction.

Serious service problems can be avoided by taking adequate precautions to assure an internally clean and dry system.

CAUTION

Dry nitrogen should always be supplied through the tubing while it is being brazed, because the temperature required is high enough to cause oxidation of the copper unless an inert atmosphere is provided. The flow of dry nitrogen should continue until the joint has cooled. Always use a pressure regulator and safety valve to insure that only low pressure dry nitrogen is introduced into the tubing. Only a small flow is necessary to displace air and prevent oxidation.

Precautions during brazing of service valve

Precautions should be taken to prevent heat damage to service valve by wrapping a wet rag around it as shown in Figure 5. Also, protect all painted surfaces, insulation, and plastic base during brazing. After brazing, cool joint with wet rag.

WARNING

This is not a backseating valve. The service access port has a valve core. Opening or closing valve does not close service access port. If the valve stem is backed out past the chamfered retaining wall, the O-ring can be damaged causing leakage or system pressure could force the valve stem out of the valve body possibly causing personal injury.

The valve can be opened by removing the service valve cap and fully inserting a hex wrench into the stem and backing out counter-clockwise until valve stem just touches the chamfered retaining wall.

Connecting the refrigerant lines

1. Remove the cap and Schrader core from both the liquid and vapor service valve service ports at the outdoor unit. Connect low pressure nitrogen to the liquid line service port.
2. Braze the liquid line to the liquid valve at the outdoor unit. Be sure to wrap the valve body with a wet rag. Allow the nitrogen to continue flowing.
3. Carefully remove the plugs from the indoor liquid and vapor connections at the indoor coil.
4. Braze the liquid line to the indoor coil liquid connection. Nitrogen should be flowing through the indoor coil.
5. Slide the grommet away from the vapor connection at the indoor coil. Braze the vapor line to the indoor coil vapor connection. After the connection has cooled, slide the grommet back into original position.
6. Protect the vapor valve with a wet rag and braze the vapor line connection to the outdoor unit. The nitrogen flow should be exiting the system from the vapor service port connection. After this connection has cooled, remove the nitrogen source from the liquid fitting service port.
7. Replace the Schrader core in the liquid and vapor valves.
8. See [Indoor expansion device](#).
9. Leak test all refrigerant piping connections including the service port flare caps to be sure they are leak tight. Do not over-tighten (between 40 in. lb and 60 in. lb maximum).
10. Evacuate the vapor line, indoor coil, and liquid line to 500 microns or less. See SECTION V: Evacuation.

11. Release the refrigerant charge into the system. Open the liquid line service valve first. Once system pressures have equalized, open the vapor line service valve. Valves can be opened by removing the valve caps and turn the valve counterclockwise using a hex head wrench. If the service valve is a ball valve, use an adjustable end wrench to turn valve stem one-quarter turn counterclockwise to open. Do not overturn or the valve stem may break or become damaged. See [Precautions during brazing of service valve](#).
12. Replace service valve cap finger tight, then tighten an additional 1/12 turn (1/2 hex flat). Cap must be replaced to prevent leaks.
13. See [System charge](#) for checking and recording system charge.

Example:

Figure 5: Heat protection

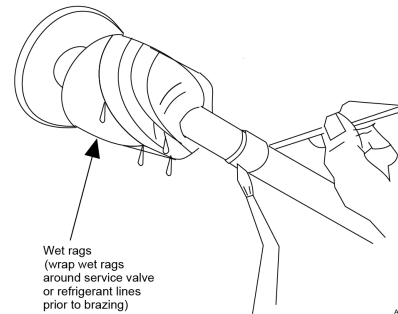

CAUTION

Do not install any coil in a furnace which is to be operated during the heating season without attaching the refrigerant lines to the coil. The coil is under pressure which must be released to prevent excessive pressure build-up and possible coil damage.

NOTICE

Line set and indoor coil can be pressurized to 250 psig with dry nitrogen and leak tested with a bubble type leak detector. Then release the nitrogen charge.

Do not use the system refrigerant in the outdoor unit to purge or leak test.

CAUTION

Do not connect manifold gauges unless trouble is suspected. Approximately 3/4 ounce of refrigerant will be lost each time a standard manifold gauge is connected.

WARNING

Never attempt to repair any brazed connections while the system is under pressure. Personal injury could result.

Indoor expansion device

Thermostatic expansion valve (TXV) installation

About this task:

The following are the basic steps for installation. For detailed instructions, refer to the *Installation Instructions* accompanying the TXV kit. Install TXV kit as follows:

► **Important:** Refer to the *Technical Guide* for the unit to determine the proper TXV kit to be used on this product.

1. Relieve the holding charge by depressing Schrader core on the suction manifold stub out.
2. After holding charge is completely discharged, loosen and remove the Schrader core.
3. Place a backup wrench on distributor, loosen and remove brass distributor nut. Retain brass nut for use on liquid line. Keep PTFE washer in place and discard clear disk.
4. Install the thermal expansion valve to the distributor assembly with supplied fittings. Ensure PTFE washer is seated in distributor. Hand tighten and turn an additional 1/4 turn to seal. Do not over-tighten fittings. See Figure 6.

CAUTION

Do not over-torque. Do not use slip joint pliers. This will distort the aluminum distributor and the brass fitting (potentially causing leaks).

5. Slide the nut removed in Step 3 over the supplied liquid line. Place supplied PTFE washer from TXV kit in place on TXV, and install liquid line to the top of the thermal expansion valve. Adjust assembly so liquid line aligns with hole in access panel. Hand tighten the liquid line, and apply an additional 1/4 turn to seal.

WARNING

Schrader valve core must not be installed with TXV installation. Poor system performance or system failure could result.

Figure 6: TXV installation

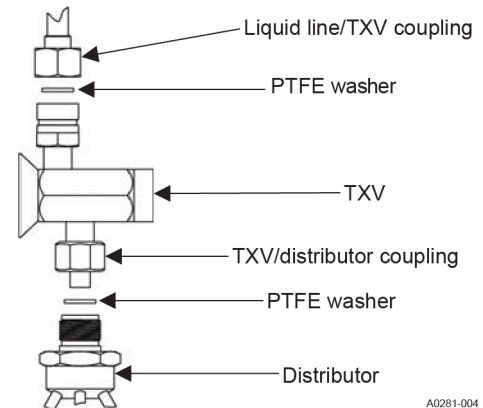

6. Install the TXV equalizer line onto the vapor line by hand tightening the 1/4 in. SAE coupling nut to the equalizer fitting, and apply an additional 1/3 turn to seal. See Figure 7.

Figure 7: TXV bulb and equalizer line installations

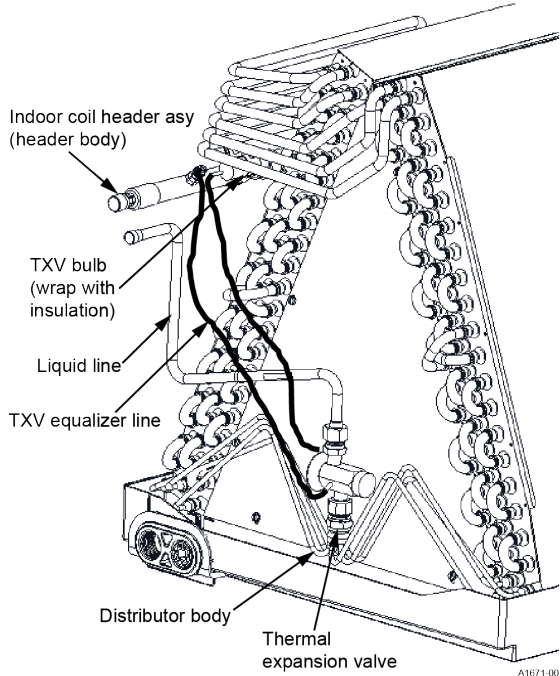

9. After line set is installed, leak test the system.

Figure 8: Proper bulb location

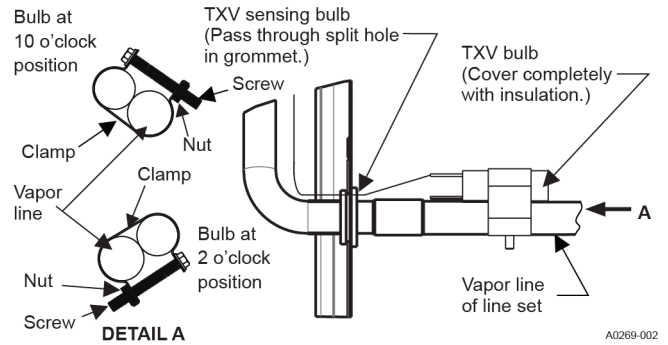

Evacuation

It will be necessary to evacuate the system to 500 microns or less. If a leak is suspected, leak test with dry nitrogen to locate the leak. Repair the leak and test again.

To verify that the system has no leaks, close the valve to the vacuum pump suction to isolate the pump and hold the system under vacuum. Watch the micron gauge for a few minutes. If the micron gauge indicates a steady and continuous rise, it is an indication of a leak. If the gauge shows a rise, then levels off after a few minutes and remains fairly constant, it is an indication the system is leak free but still contains moisture and may require further evacuation if the reading is above 500 microns.

System charge

CAUTION

In all cases, mount the TXV bulb after vapor line is brazed and has had sufficient time to cool. Failure to use suction line grommet may result in premature TXV failure.

7. If the indoor coil is an **A** coil, skip to Step 8. If not, pass the TXV temperature sensing bulb through the suction line split grommet in the access panel.
8. Install the TXV bulb to the vapor line using the bulb clamps furnished with the TXV assembly. Ensure the bulb is making maximum contact. See Figure 7 and Figure 8.
 - a. If possible, install the temperature bulb on a horizontal run of the vapor line. Ensure that the bulb is installed at a 10 o'clock or 2 o'clock position. See Figure 8.
 - b. If bulb installation is made on a vertical run, ensure that the bulb is a minimum of 8 in. (20.3 cm) away from the elbow coming out of the coil. Position the bulb with the tail of the bulb at the top, so that the bulb acts as a reservoir.
 - c. Insulate the bulb using thermal insulation provided to protect it from the effect of the surrounding ambient temperature. Cover completely to insulate.

CAUTION

If a field installed device is placed in the inner-connecting refrigerant lines that can store a significant refrigerant charge (for example, a refrigerant mass flow meter or a liquid receiver), the unit may not perform as designed. If such a performance-affecting device is installed and it is possible to check the unit in heating mode, the unit pressures should be confirmed in heating mode. See the heating charging charts located in this installation manual.

CAUTION

Refrigerant charging should only be carried out by a licensed qualified air conditioning contractor.

To ensure that the unit performs at the published levels, it is important to determine the indoor airflow and add refrigerant charge accordingly.

Measuring indoor airflow

To determine the rated airflow for a specific match, refer to the technical literature available at www.simplygettingthejobdone.com. When attempting to match this air flow, select the lowest possible speed tap, measure the actual flow, and adjust as necessary.

About this task:

To measure actual airflow, it is not an acceptable method to just check the jumper pin setting tables and assume 0.5 in. W.C total external static pressure.

To determine indoor airflow, follow these steps:

1. On a gas furnace or single-piece air handler, measure the static pressure with a manometer between the filter and return air opening of the indoor equipment. On a modular air handler, measure the return air static pressure between the indoor coil and entering air side of the modular air handler.
2. Perform a **OR** b.
 - a. On a single-piece or modular air handler, take a second reading in the supply air ductwork leaving the indoor equipment.
 - b. On a gas furnace, take a second reading after the heat exchanger, but before the indoor coil.
3. Add the negative return static to the positive supply static to determine the total system static pressure. Treat the negative return static as a positive pressure (even though it is a negative reading). If there is static pressure on the blower return (for example, -0.1 in. W.C.), add it to a supply static (0.4 in. W.C.) that equals the total system static pressure (0.5 in. W.C.).
4. Compare this value to the indoor blower performance charts, ensuring air flow is between 350 CFM to 450 CFM per ton of cooling.

Charging the unit

CAUTION

Always charge in liquid form. Take care not to slug the compressor.

The factory charge in the outdoor unit includes enough charge for the unit, 15 ft (4.6 m) of refrigerant piping, and the smallest indoor coil or air handler match-up. Some indoor coil or air handler matches may require additional charge.

CAUTION

Compressor damage will occur if system is improperly charged. On new system installations, charge system according to the *Tabular Data Sheet* for the matched coil and follow guidelines in this instruction.

Refer to the *Tabular Data Sheet* provided in the customer booklet for the unit for charge requirements. You must permanently mark the total system charge on the unit data plate.

CAUTION

Do not leave the system open to the atmosphere. Unit damage could occur due to moisture being absorbed by the POE oil in the system. This type of oil is highly susceptible to moisture absorption.

Determining the total system charge

1. Determine the outdoor unit factory charge using the *Tabular Data Sheet*.
2. Determine the indoor coil adjustment (if any) using the *Tabular Data Sheet*.
3. Calculate the additional charge for the refrigerant piping using the *Tabular Data Sheet* if the line length is greater than 15 ft (4.6 m).
4. Note that the total system charge = item 1 + item 2 + item 3.
5. Check the unit against the pressure value listed on the cooling chart on the unit or the appropriate heat charging chart in this manual. Make any adjustment necessary.
6. Add or subtract refrigerant to obtain the pressure listed on the charging chart. Make sure to adjust the total system charge by the amount added or removed to obtain the charging chart pressures. Permanently mark the unit data plate with the total amount of refrigerant in the system.

WARNING

Do not attempt to pump Total System Charge into outdoor unit for maintenance or service. This may cause damage to the compressor or other components. Recover and weigh System Charge into an appropriate recovery cylinder for any instances requiring evacuation.

CAUTION

It is unlawful to knowingly vent, release, or discharge refrigerant into the open air during repair, service, maintenance or the final disposal of this unit.

Charging with gauges

About this task:

CAUTION

Refrigerant charging must only be carried out by a qualified air conditioning contractor.

Note: All pressures/subcool valves shown are with the compressor on high stage. System must be charged with the compressor at full capacity.

All units include a cooling charging chart for the most common indoor application in upflow orientation. For all other cooling charging charts and the heating charging charts, see Table 3 to Table 44. You can also access these charts in the Service Application Data section at www.simplygettingthejobdone.com.

CAUTION

Compressor damage will occur if system is improperly charged. On new system installations, charge system according to the *Tabular Data Sheet* for the matched coil and follow guidelines in this instruction.

To charge with gauges, follow these steps:

1. Before using the gauges, confirm that the gauges are accurate by comparing the gauges against a calibrated pressure gauge that has been calibrated against a national standard. If a calibrated pressure gauge is not available, place a R-410A virgin refrigerant container in a conditioned space long enough to come to temperature equilibrium with the surroundings. Then measure the temperature of the air and the pressure of the refrigerant and compare it to the following table:

Table 2: R-410A saturation properties

Temp (°F)	Pressure (psig)	Temp (°F)	Pressure (psig)	Temp (°F)	Pressure (psig)
40	119	75	218	110	365
45	130	80	236	115	391
50	143	85	255	120	418
55	156	90	274	125	447
60	170	95	295	130	477
65	185	100	317	-	-
70	201	105	341	-	-

2. Locate the applicable cooling chart in Table 3 to Table 23 or heating chart in Table 24 to Table 44 for the indoor coil and orientation. Use the method outlined in [Measuring indoor airflow](#) to calculate the airflow, then consult the correct table and match the liquid pressure to that airflow.

Subcooling charging charts

Table 3: 1.5 ton cooling charging chart for XAF*24B, XAF*30C, JH(E,V)*18B, and JH(E,V)T*24C in upflow

Outdoor ambient DB (°F)	Indoor wet bulb (°F) at 80°F dry bulb			
	57	62	67	72
	Pressure (psig) and subcooling (°F) at liquid base value			
55	195 (7)	196 (7)	198 (7)	203 (5)
60	213 (6)	214 (7)	216 (6)	219 (5)
65	231 (6)	231 (7)	234 (6)	236 (5)
70	249 (5)	249 (7)	252 (6)	254 (5)
75	266 (5)	267 (7)	269 (6)	272 (6)
80	289 (5)	289 (7)	292 (6)	295 (6)
85	311 (6)	311 (7)	314 (6)	317 (6)
90	333 (7)	333 (7)	336 (6)	339 (6)
95	355 (8)	355 (8)	358 (7)	361 (7)
100	384 (8)	384 (8)	387 (7)	390 (7)
105	413 (8)	413 (8)	415 (8)	419 (7)
110	441 (8)	441 (8)	443 (8)	447 (7)
115	470 (8)	469 (9)	472 (9)	475 (8)
120	498 (8)	497 (9)	500 (9)	503 (8)
125	527 (9)	526 (9)	528 (9)	532 (9)

Table 4: 1.5 ton cooling charging chart for XAH24B, XAH*30C, JH(E,V)*18B, and JH(E,V)T*24C in horizontal left

Outdoor ambient DB (°F)	Indoor wet bulb (°F) at 80°F dry bulb			
	57	62	67	72
	Pressure (psig) and subcooling (°F) at liquid base valve			
55	199 (7)	200 (7)	202 (7)	207 (5)
60	218 (7)	218 (7)	221 (7)	224 (5)
65	236 (6)	236 (7)	239 (6)	241 (5)
70	254 (6)	254 (7)	257 (6)	260 (6)
75	272 (5)	273 (7)	275 (6)	278 (6)
80	295 (6)	295 (7)	298 (6)	301 (6)
85	318 (6)	318 (7)	321 (6)	324 (6)
90	340 (7)	340 (8)	343 (7)	346 (7)
95	363 (8)	363 (8)	368 (7)	369 (7)
100	392 (8)	392 (8)	394 (8)	398 (7)
105	421 (8)	421 (8)	423 (8)	427 (7)
110	450 (8)	450 (9)	452 (9)	456 (8)
115	479 (8)	478 (9)	481 (9)	484 (8)
120	508 (9)	507 (9)	510 (9)	514 (9)
125	538 (9)	537 (9)	539 (9)	543 (9)

Table 5: 1.5 ton cooling charging chart for XA(F,H)*24B, XA(F,H)*30C, JH(E,V)*18B, and JH(E,V)T*24C in downflow and horizontal right

Outdoor ambient DB (°F)	Indoor wet bulb (°F) at 80°F dry bulb			
	57	62	67	72
	Pressure (psig) and subcooling (°F) at liquid base valve			
55	197 (4)	198 (4)	200 (4)	204 (3)
60	215 (3)	215 (4)	218 (3)	221 (3)
65	233 (3)	233 (4)	236 (3)	238 (3)
70	251 (3)	251 (4)	254 (3)	256 (3)
75	268 (3)	269 (4)	272 (3)	275 (3)
80	291 (3)	292 (4)	294 (3)	297 (3)
85	314 (3)	314 (4)	317 (3)	320 (3)
90	336 (4)	336 (4)	339 (3)	342 (3)
95	358 (4)	358 (4)	363 (4)	364 (4)
100	387 (4)	387 (4)	390 (4)	393 (4)
105	416 (4)	416 (4)	418 (4)	422 (4)
110	445 (4)	444 (5)	447 (5)	450 (4)
115	473 (4)	472 (5)	475 (5)	478 (4)
120	502 (5)	501 (5)	504 (5)	507 (5)
125	531 (5)	530 (5)	532 (5)	536 (5)

Table 6: 2 ton cooling charging chart for XA(F,H)*30C and JH(E,V)T*24C in upflow and horizontal left

Outdoor ambient DB (°F)	Indoor wet bulb (°F) at 80°F dry bulb			
	57	62	67	72
	Pressure (psig) and subcooling (°F) at liquid base valve			
55	222 (16)	215 (15)	228 (17)	234 (18)
60	243 (17)	239 (16)	250 (18)	255 (18)
65	264 (17)	262 (17)	271 (18)	276 (18)
70	284 (17)	285 (18)	291 (18)	297 (19)
75	305 (17)	308 (18)	312 (18)	318 (19)
80	330 (18)	333 (19)	337 (19)	343 (19)
85	356 (18)	358 (19)	363 (19)	369 (19)
90	381 (18)	383 (19)	388 (19)	394 (20)
95	407 (18)	408 (19)	413 (19)	420 (20)
100	439 (19)	441 (20)	446 (20)	452 (20)
105	472 (19)	474 (20)	479 (20)	485 (20)
110	505 (19)	507 (20)	512 (20)	518 (21)
115	538 (19)	540 (20)	545 (20)	550 (21)
120	571 (20)	573 (21)	578 (21)	583 (21)
125	604 (20)	606 (21)	611 (21)	615 (21)

Table 7: 2 ton cooling charging chart for XA(F,H)*30C and JH(E,V)T*24C in downflow and horizontal right

Outdoor ambient DB (°F)	Indoor wet bulb (°F) at 80°F dry bulb			
	57	62	67	72
	Pressure (psig) and subcooling (°F) at liquid base valve			
55	212 (4)	206 (4)	218 (4)	223 (4)
60	232 (4)	228 (4)	238 (4)	243 (4)
65	251 (4)	250 (4)	258 (4)	263 (4)
70	271 (4)	272 (4)	278 (4)	283 (5)
75	291 (4)	294 (4)	297 (4)	303 (5)
80	315 (4)	317 (5)	322 (5)	328 (5)
85	339 (4)	341 (5)	346 (5)	352 (5)
90	364 (4)	365 (5)	370 (5)	376 (5)
95	388 (4)	389 (5)	394 (5)	401 (5)
100	419 (5)	421 (5)	426 (5)	432 (5)
105	450 (5)	452 (5)	457 (5)	463 (5)
110	482 (5)	484 (5)	489 (5)	494 (5)
115	514 (5)	515 (5)	520 (5)	525 (5)
120	545 (5)	547 (5)	552 (5)	556 (5)
125	577 (5)	579 (5)	583 (5)	587 (5)

Table 8: 2.5 ton cooling charging chart for XAF*36D and JH(E,V)T*(30,36)D in upflow

Outdoor ambient DB (°F)	Indoor wet bulb (°F) at 80°F dry bulb			
	57	62	67	72
	Pressure (psig) and subcooling (°F) at liquid base valve			
55	210 (10)	212 (10)	215 (11)	220 (11)
60	230 (10)	231 (10)	235 (11)	239 (11)
65	249 (10)	250 (11)	254 (11)	258 (12)
70	270 (10)	270 (11)	274 (11)	278 (12)
75	290 (11)	290 (12)	293 (11)	298 (12)
80	315 (11)	315 (12)	317 (11)	322 (12)
85	339 (12)	339 (13)	342 (12)	347 (13)
90	365 (12)	364 (13)	366 (12)	371 (13)
95	390 (13)	388 (13)	391 (13)	395 (14)
100	422 (13)	420 (13)	424 (13)	427 (14)
105	453 (14)	452 (14)	457 (14)	459 (14)
110	484 (14)	484 (14)	489 (14)	491 (14)
115	516 (14)	517 (14)	522 (15)	523 (15)
120	547 (14)	549 (14)	555 (15)	555 (15)
125	578 (14)	581 (15)	588 (15)	587 (15)

Table 9: 2.5 ton cooling charging chart for XAH*36D and JH(E,V)T*(30,36)D in horizontal left

Outdoor ambient DB (°F)	Indoor wet bulb (°F) at 80°F dry bulb			
	57	62	67	72
	Pressure (psig) and subcooling (°F) at liquid base valve			
55	214 (13)	216 (13)	219 (14)	224 (14)
60	234 (13)	235 (14)	239 (14)	243 (15)
65	254 (13)	255 (14)	259 (14)	263 (15)
70	274 (14)	275 (15)	279 (14)	283 (15)
75	295 (14)	295 (15)	298 (14)	303 (15)
80	320 (15)	320 (16)	323 (15)	328 (16)
85	346 (15)	346 (16)	348 (15)	353 (16)
90	371 (16)	370 (16)	373 (16)	378 (17)
95	397 (16)	395 (16)	398 (16)	402 (17)
100	429 (17)	428 (17)	432 (17)	435 (17)
105	461 (17)	460 (17)	465 (17)	467 (17)
110	493 (17)	493 (17)	498 (18)	500 (18)
115	525 (17)	526 (17)	531 (18)	532 (18)
120	557 (17)	559 (18)	565 (19)	565 (18)
125	588 (17)	591 (18)	599 (19)	597 (18)

Table 10: 2.5 ton cooling charging chart for XA(F,H)*36D and JH(E,V)T*(30,36)D in downflow and horizontal right

Outdoor ambient DB (°F)	Indoor wet bulb (°F) at 80°F dry bulb			
	57	62	67	72
	Pressure (psig) and subcooling (°F) at liquid base valve			
55	198 (5)	200 (5)	203 (6)	208 (6)
60	217 (5)	219 (6)	222 (6)	226 (6)
65	236 (5)	237 (6)	241 (6)	244 (6)
70	255 (6)	255 (6)	259 (6)	263 (6)
75	274 (6)	274 (6)	277 (6)	282 (6)
80	298 (6)	298 (7)	300 (6)	305 (7)
85	321 (6)	321 (7)	323 (6)	328 (7)
90	345 (7)	344 (7)	347 (7)	351 (7)
95	369 (7)	367 (7)	371 (7)	374 (8)
100	399 (7)	397 (7)	401 (7)	404 (8)
105	428 (8)	428 (8)	432 (8)	434 (8)
110	458 (8)	458 (8)	463 (8)	464 (8)
115	488 (8)	489 (8)	494 (8)	495 (8)
120	517 (8)	519 (8)	525 (8)	525 (8)
125	546 (8)	549 (8)	556 (9)	555 (8)

Table 11: 3 ton cooling charging chart for XAF*36D and JH(E,V)T*36D in upflow

Outdoor ambient DB (°F)	Indoor wet bulb (°F) at 80°F dry bulb			
	57	62	67	72
	Pressure (psig) and subcooling (°F) at liquid base valve			
55	203 (12)	206 (13)	208 (14)	212 (14)
60	223 (12)	226 (13)	228 (14)	232 (14)
65	242 (13)	245 (14)	247 (14)	251 (14)
70	261 (13)	265 (14)	266 (14)	271 (14)
75	280 (13)	284 (14)	285 (14)	290 (14)
80	306 (13)	309 (14)	310 (14)	315 (14)
85	331 (14)	333 (15)	335 (15)	339 (15)
90	356 (14)	358 (15)	360 (15)	364 (15)
95	381 (15)	383 (15)	385 (15)	389 (16)
100	413 (15)	415 (15)	418 (15)	421 (16)
105	445 (15)	447 (16)	450 (16)	453 (16)
110	478 (15)	479 (16)	482 (16)	485 (16)
115	510 (16)	511 (17)	514 (17)	517 (17)
120	542 (16)	543 (17)	547 (17)	550 (17)
125	574 (17)	575 (17)	579 (18)	582 (18)

Table 12: 3 ton cooling charging chart for XAH*36D and JH(E,V)T*36D in horizontal left

Outdoor ambient DB (°F)	Indoor wet bulb (°F) at 80°F dry bulb			
	57	62	67	72
	Pressure (psig) and subcooling (°F) at liquid base valve			
55	207 (11)	210 (12)	212 (13)	217 (13)
60	227 (12)	230 (13)	232 (13)	236 (13)
65	247 (12)	250 (13)	252 (13)	256 (13)
70	266 (12)	270 (13)	271 (13)	276 (13)
75	286 (12)	290 (13)	291 (13)	296 (13)
80	312 (13)	315 (14)	316 (14)	321 (14)
85	338 (13)	340 (14)	342 (14)	346 (14)
90	363 (14)	365 (14)	367 (14)	371 (15)
95	389 (14)	391 (14)	393 (14)	397 (15)
100	421 (14)	423 (15)	426 (15)	429 (15)
105	454 (14)	456 (15)	459 (15)	462 (15)
110	487 (15)	488 (16)	492 (16)	495 (16)
115	520 (15)	521 (16)	524 (16)	527 (16)
120	553 (16)	554 (16)	557 (17)	560 (17)
125	585 (16)	586 (16)	590 (17)	594 (17)

Table 13: 3 ton cooling charging chart for XA(F,H)*36D and JH(E,V)T*36D in downflow and horizontal right

Outdoor ambient DB (°F)	Indoor wet bulb (°F) at 80°F dry bulb			
	57	62	67	72
	Pressure (psig) and subcooling (°F) at liquid base valve			
55	196 (9)	199 (9)	201 (10)	205 (10)
60	215 (9)	218 (10)	219 (10)	223 (10)
65	233 (9)	236 (10)	238 (10)	242 (10)
70	252 (9)	255 (10)	257 (10)	261 (10)
75	270 (9)	274 (10)	275 (10)	280 (10)
80	295 (10)	298 (11)	299 (11)	303 (11)
85	319 (10)	321 (11)	323 (11)	327 (11)
90	343 (11)	345 (11)	347 (11)	351 (11)
95	368 (11)	370 (11)	372 (11)	375 (12)
100	398 (11)	400 (11)	403 (11)	406 (12)
105	429 (11)	431 (12)	434 (12)	437 (12)
110	461 (11)	462 (12)	465 (12)	468 (12)
115	492 (12)	493 (12)	496 (12)	499 (12)
120	523 (12)	524 (12)	527 (13)	530 (13)
125	554 (12)	555 (12)	559 (13)	562 (13)

Table 14: 3.5 ton cooling charging chart for XA(F,H)*48F, XA(F,H)*60G, JH(E,V)T*42F, and JH(E,V)T*48G in upflow or horizontal left

Outdoor ambient DB (°F)	Indoor wet bulb (°F) at 80°F dry bulb			
	57	62	67	72
	Pressure (psig) and subcooling (°F) at liquid base valve			
55	203 (9)	206 (9)	209 (10)	213 (11)
60	222 (9)	225 (10)	228 (10)	232 (11)
65	241 (9)	243 (10)	246 (10)	250 (10)
70	261 (9)	262 (10)	265 (10)	269 (10)
75	280 (9)	281 (10)	283 (9)	287 (10)
80	305 (9)	305 (10)	307 (10)	311 (10)
85	329 (9)	329 (10)	331 (10)	335 (10)
90	353 (10)	354 (11)	356 (10)	359 (10)
95	377 (10)	378 (11)	380 (10)	383 (10)
100	408 (10)	408 (11)	410 (11)	413 (10)
105	439 (10)	439 (11)	441 (11)	444 (10)
110	470 (11)	470 (12)	472 (11)	474 (11)
115	501 (11)	501 (12)	503 (11)	505 (11)
120	532 (12)	532 (12)	534 (12)	536 (11)
125	563 (12)	563 (12)	565 (12)	567 (11)

Table 15: 3.5 ton cooling charging chart for XA(F,H)*48F and JH(E,V)T*42F in downflow and horizontal right

Outdoor ambient DB (°F)	Indoor wet bulb (°F) at 80°F dry bulb			
	57	62	67	72
	Pressure (psig) and subcooling (°F) at liquid base valve			
55	197 (5)	200 (5)	203 (5)	206 (6)
60	216 (5)	218 (5)	221 (5)	225 (5)
65	234 (5)	236 (5)	239 (5)	243 (5)
70	253 (5)	254 (5)	257 (5)	261 (5)
75	272 (5)	273 (5)	275 (5)	278 (5)
80	295 (5)	296 (5)	298 (5)	302 (5)
85	319 (5)	319 (5)	321 (5)	325 (5)
90	342 (5)	343 (5)	345 (5)	348 (5)
95	365 (5)	366 (6)	369 (5)	371 (5)
100	395 (5)	396 (6)	398 (5)	401 (5)
105	425 (5)	425 (6)	427 (6)	430 (5)
110	455 (5)	455 (6)	457 (6)	460 (5)
115	485 (6)	485 (6)	487 (6)	489 (6)
120	515 (6)	515 (6)	517 (6)	519 (6)
125	545 (6)	545 (6)	547 (6)	549 (6)

Table 16: 4 ton cooling charging chart for XAF*60G and JH(E,V)T*48G in upflow

Outdoor ambient DB (°F)	Indoor wet bulb (°F) at 80°F dry bulb			
	57	62	67	72
	Pressure (psig) and subcooling (°F) at liquid base valve			
55	220 (13)	224 (14)	227 (14)	231 (15)
60	241 (14)	245 (15)	247 (15)	251 (15)
65	261 (14)	265 (15)	267 (15)	271 (15)
70	281 (14)	285 (15)	288 (15)	291 (15)
75	301 (14)	305 (15)	308 (15)	311 (15)
80	327 (15)	331 (16)	333 (16)	337 (16)
85	352 (15)	356 (16)	358 (16)	362 (16)
90	378 (16)	381 (16)	384 (16)	387 (16)
95	403 (16)	406 (16)	409 (16)	412 (16)
100	435 (16)	439 (17)	441 (17)	445 (17)
105	468 (16)	472 (17)	474 (17)	478 (17)
110	500 (17)	504 (18)	507 (18)	511 (18)
115	533 (17)	537 (18)	540 (18)	544 (18)
120	566 (18)	569 (19)	573 (19)	576 (18)
125	599 (18)	602 (19)	606 (19)	609 (18)

Table 18: 4 ton cooling charging chart for XA(F,H)*60G and JH(E,V)T*48G in downflow and horizontal right

Outdoor ambient DB (°F)	Indoor wet bulb (°F) at 80°F dry bulb			
	57	62	67	72
	Pressure (psig) and subcooling (°F) at liquid base valve			
55	204 (10)	208 (11)	210 (11)	214 (12)
60	223 (10)	227 (11)	229 (11)	232 (12)
65	242 (11)	246 (12)	247 (12)	251 (12)
70	260 (11)	264 (12)	266 (12)	269 (12)
75	279 (11)	282 (12)	285 (12)	288 (12)
80	302 (11)	306 (12)	308 (12)	311 (12)
85	326 (12)	329 (12)	331 (12)	335 (12)
90	349 (12)	353 (12)	355 (12)	358 (12)
95	373 (12)	376 (12)	379 (12)	381 (12)
100	403 (12)	406 (13)	408 (13)	412 (13)
105	433 (12)	437 (13)	438 (13)	442 (13)
110	463 (13)	467 (14)	469 (14)	473 (14)
115	493 (13)	497 (14)	499 (14)	503 (14)
120	523 (14)	527 (14)	530 (14)	533 (14)
125	554 (14)	557 (15)	560 (15)	563 (14)

Table 17: 4 ton cooling charging chart for XAH*60G and JH(E,V)T*48G in horizontal left

Outdoor ambient DB (°F)	Indoor wet bulb (°F) at 80°F dry bulb			
	57	62	67	72
	Pressure (psig) and subcooling (°F) at liquid base valve			
55	223 (16)	228 (17)	231 (17)	234 (18)
60	244 (16)	248 (18)	251 (18)	255 (18)
65	265 (17)	269 (18)	271 (18)	275 (18)
70	285 (17)	289 (18)	292 (18)	295 (18)
75	305 (17)	309 (18)	312 (18)	316 (18)
80	331 (18)	335 (19)	338 (19)	341 (19)
85	357 (18)	361 (20)	363 (20)	367 (20)
90	383 (19)	386 (20)	389 (20)	392 (20)
95	409 (20)	412 (20)	415 (20)	418 (20)
100	441 (20)	445 (20)	447 (20)	451 (20)
105	474 (20)	478 (21)	480 (21)	484 (21)
110	507 (20)	511 (21)	514 (21)	518 (21)
115	540 (21)	544 (22)	547 (22)	551 (22)
120	573 (21)	577 (23)	580 (23)	584 (22)
125	607 (22)	610 (23)	614 (23)	617 (22)

Table 19: 5 ton cooling charging chart for XAF*60H and JH(E,V)T*60H in upflow

Outdoor ambient DB (°F)	Indoor wet bulb (°F) at 80°F dry bulb			
	57	62	67	72
	Pressure (psig) and subcooling (°F) at liquid base valve			
55	204 (10)	210 (11)	213 (12)	215 (13)
60	223 (9)	228 (11)	231 (11)	234 (12)
65	242 (9)	247 (11)	250 (11)	254 (12)
70	261 (9)	265 (10)	268 (10)	273 (11)
75	279 (9)	283 (10)	286 (10)	291 (11)
80	303 (9)	307 (10)	310 (10)	314 (11)
85	327 (9)	330 (10)	333 (10)	337 (11)
90	352 (9)	354 (10)	357 (10)	361 (11)
95	376 (10)	377 (10)	380 (10)	384 (11)
100	406 (10)	407 (10)	410 (10)	415 (11)
105	436 (10)	437 (11)	440 (11)	445 (11)
110	466 (10)	467 (11)	471 (11)	475 (11)
115	496 (11)	497 (11)	501 (11)	505 (11)
120	527 (11)	528 (11)	532 (11)	536 (11)
125	557 (11)	558 (11)	562 (11)	566 (11)

Table 20: 5 ton cooling charging chart for XA(F,H)*60H and JH(E,V)T*60H in downflow, horizontal right, or horizontal left

Outdoor ambient DB (°F)	Indoor wet bulb (°F) at 80°F dry bulb			
	57	62	67	72
	Pressure(psig) and subcooling (°F) at liquid base valve			
55	209 (12)	215 (13)	218 (14)	221 (15)
60	229 (11)	234 (13)	237 (14)	241 (15)
65	248 (11)	253 (13)	256 (13)	260 (14)
70	268 (11)	272 (12)	275 (12)	280 (14)
75	287 (11)	291 (12)	294 (12)	299 (13)
80	312 (11)	315 (12)	318 (12)	323 (13)
85	336 (11)	339 (12)	342 (12)	346 (13)
90	361 (11)	363 (12)	366 (12)	371 (13)
95	386 (12)	387 (12)	390 (12)	395 (13)
100	417 (12)	418 (12)	421 (12)	426 (13)
105	448 (12)	449 (13)	452 (13)	457 (13)
110	479 (12)	480 (13)	483 (13)	488 (13)
115	509 (13)	511 (13)	515 (13)	519 (13)
120	541 (13)	542 (13)	546 (13)	550 (13)
125	572 (13)	573 (13)	577 (13)	581 (13)

Table 21: 5 ton cooling charging chart for XAF*60J and JH(E,V)T*60J in upflow

Outdoor ambient DB (°F)	Indoor wet bulb (°F) at 80°F dry bulb			
	57	62	67	72
	Pressure(psig) and subcooling (°F) at liquid base valve			
55	208 (9)	211 (10)	215 (11)	218 (12)
60	226 (9)	229 (10)	233 (11)	237 (12)
65	245 (9)	248 (10)	252 (11)	256 (11)
70	264 (9)	266 (10)	270 (11)	275 (11)
75	283 (9)	285 (10)	289 (10)	294 (11)
80	307 (9)	309 (10)	312 (10)	318 (11)
85	332 (9)	333 (10)	336 (10)	342 (11)
90	356 (10)	357 (11)	360 (10)	366 (11)
95	381 (10)	381 (11)	384 (10)	390 (11)
100	412 (10)	412 (11)	415 (11)	421 (11)
105	443 (10)	443 (11)	447 (11)	453 (11)
110	474 (11)	474 (11)	478 (11)	484 (12)
115	506 (11)	505 (11)	510 (11)	515 (12)
120	537 (12)	536 (12)	541 (12)	546 (12)
125	568 (12)	567 (12)	573 (12)	578 (12)

Table 22: 5 ton cooling charging chart for XAH*60J and JH(E,V)T*60J in horizontal left

Outdoor ambient DB (°F)	Indoor wet bulb (°F) at 80°F dry bulb			
	57	62	67	72
	Pressure(psig) and subcooling (°F) at liquid base valve			
55	213 (12)	216 (13)	220 (15)	223 (16)
60	232 (12)	235 (13)	239 (15)	242 (15)
65	251 (12)	254 (13)	258 (15)	262 (15)
70	270 (12)	273 (13)	277 (14)	281 (15)
75	289 (12)	292 (13)	296 (13)	301 (15)
80	315 (12)	316 (13)	320 (13)	325 (15)
85	340 (12)	341 (13)	344 (13)	350 (15)
90	365 (13)	365 (14)	368 (13)	374 (15)
95	390 (13)	390 (15)	392 (13)	399 (15)
100	421 (13)	421 (15)	425 (14)	431 (15)
105	453 (13)	453 (15)	457 (15)	463 (15)
110	485 (14)	485 (15)	489 (15)	495 (15)
115	518 (15)	517 (15)	522 (15)	527 (16)
120	549 (15)	548 (15)	554 (15)	559 (16)
125	581 (16)	580 (16)	586 (16)	591 (16)

Table 23: 5 ton cooling charging chart for XA(F,H)*60J and JH(E,V)T*60J in downflow and horizontal right

Outdoor ambient DB (°F)	Indoor wet bulb (°F) at 80°F dry bulb			
	57	62	67	72
	Pressure(psig) and subcooling (°F) at liquid base valve			
55	202 (5)	205 (6)	209 (6)	212 (7)
60	220 (5)	223 (6)	227 (6)	230 (7)
65	238 (5)	241 (6)	245 (6)	249 (6)
70	257 (5)	259 (6)	263 (6)	267 (6)
75	275 (5)	277 (6)	281 (6)	286 (6)
80	299 (5)	300 (6)	304 (6)	309 (6)
85	323 (5)	324 (6)	326 (6)	332 (6)
90	346 (5)	347 (6)	350 (6)	356 (6)
95	370 (6)	370 (6)	373 (6)	379 (6)
100	400 (6)	400 (6)	404 (6)	410 (6)
105	430 (6)	430 (6)	434 (6)	440 (6)
110	461 (6)	461 (6)	465 (6)	470 (7)
115	492 (6)	491 (6)	496 (6)	500 (7)
120	522 (7)	521 (7)	526 (7)	531 (7)
125	552 (7)	551 (7)	557 (7)	562 (7)

Heating charging charts

Table 24: 1.5 ton heating charging chart for XA(F,H)*24B and JH(E,V)T*18B in upflow and horizontal left

CFM	Ambient temperature (°F)	60			47			40			30			17			10			0		
	Indoor temperature (°F)	60	70	80	60	70	80	60	70	80	60	70	80	60	70	80	60	70	80	60	70	80
450	Liquid pressure (subcool)	337 (20)	378 (20)	419 (20)	309 (22)	352 (24)	395 (26)	294 (24)	336 (25)	379 (27)	275 (29)	316 (29)	358 (28)	269 (29)	306 (30)	344 (31)	255 (31)	294 (31)	333 (32)	255 (29)	273 (29)	290 (30)
585	Liquid pressure (subcool)	316 (19)	357 (19)	398 (20)	288 (19)	327 (19)	378 (25)	281 (23)	323 (25)	365 (27)	263 (27)	305 (27)	347 (27)	251 (25)	280 (23)	325 (28)	239 (27)	277 (28)	315 (29)	241 (30)	260 (29)	280 (28)
750	Liquid pressure (subcool)	294 (19)	335 (19)	376 (19)	267 (17)	314 (21)	360 (25)	267 (23)	309 (24)	351 (26)	252 (25)	294 (26)	337 (26)	233 (21)	269 (22)	305 (24)	224 (23)	260 (24)	297 (26)	227 (31)	248 (28)	269 (26)
-	Suction pressure	132	133	134	107	107	108	95	96	97	79	80	82	61	60	63	52	53	54	42	42	43

Table 25: 1.5 ton heating charging chart for XA(F,H)*24B and JH(E,V)T*18B in downflow and horizontal right

CFM	Ambient temperature (°F)	60			47			40			30			17			10			0		
	Indoor temperature (°F)	60	70	80	60	70	80	60	70	80	60	70	80	60	70	80	60	70	80	60	70	80
450	Liquid pressure (subcool)	353 (19)	395 (19)	438 (19)	322 (20)	368 (22)	413 (24)	307 (22)	352 (24)	395 (26)	287 (28)	330 (27)	373 (27)	272 (27)	309 (28)	347 (29)	257 (29)	297 (29)	336 (30)	257 (27)	276 (27)	293 (28)
600	Liquid pressure (subcool)	324 (17)	366 (18)	408 (18)	295 (18)	333 (20)	387 (23)	288 (21)	331 (22)	374 (24)	270 (24)	313 (24)	356 (24)	251 (25)	288 (26)	325 (28)	239 (27)	277 (28)	315 (29)	241 (30)	260 (29)	280 (28)
750	Liquid pressure (subcool)	294 (17)	335 (17)	376 (17)	267 (15)	314 (19)	360 (22)	267 (21)	309 (22)	351 (23)	252 (22)	294 (23)	337 (23)	236 (24)	273 (24)	309 (27)	227 (26)	264 (27)	301 (30)	230 (35)	251 (32)	273 (30)
-	Suction pressure	137	138	139	112	111	113	99	99	100	82	84	86	63	62	65	54	55	56	43	43	44

Table 26: 1.5 ton heating charging chart for XA(F,H)*30C and JH(E,V)T*24C in upflow and horizontal left

CFM	Ambient temperature (°F)	60			47			40			30			17			10			0		
	Indoor temperature (°F)	60	70	80	60	70	80	60	70	80	60	70	80	60	70	80	60	70	80	60	70	80
475	Liquid pressure (subcool)	315 (10)	354 (10)	392 (11)	287 (13)	328 (14)	370 (16)	275 (14)	315 (16)	355 (18)	258 (20)	296 (19)	335 (19)	244 (20)	277 (21)	312 (22)	231 (22)	267 (23)	302 (23)	231 (23)	247 (24)	263 (25)
600	Liquid pressure (subcool)	286 (10)	323 (10)	359 (10)	260 (10)	301 (13)	341 (16)	254 (13)	292 (15)	330 (17)	238 (17)	276 (17)	314 (18)	229 (17)	263 (18)	297 (19)	218 (19)	253 (20)	288 (21)	220 (24)	237 (24)	255 (23)
755	Liquid pressure (subcool)	267 (9)	304 (9)	342 (9)	242 (7)	286 (11)	327 (16)	242 (13)	281 (15)	319 (17)	230 (15)	267 (16)	306 (17)	220 (16)	254 (18)	288 (19)	211 (18)	245 (19)	280 (21)	207 (25)	226 (23)	245 (20)
-	Suction pressure	132	133	134	107	107	108	95	95	96	78	80	82	60	61.00	62	51	52	53	41	41	42

Table 27: 1.5 ton heating charging chart for XA(F,H)*30C and JH(E,V)T*24C in downflow and horizontal right

CFM	Ambient temperature (°F)	60			47			40			30			17			10			0		
	Indoor temperature (°F)	60	70	80	60	70	80	60	70	80	60	70	80	60	70	80	60	70	80	60	70	80
450	Liquid pressure (subcool)	339 (12)	381 (12)	421 (13)	310 (15)	349 (16)	398 (19)	296 (16)	338 (19)	381 (21)	277 (23)	318 (22)	360 (22)	256 (23)	288 (24)	326 (25)	242 (25)	279 (27)	316 (27)	242 (27)	259 (28)	275 (29)
600	Liquid pressure (subcool)	301 (11)	340 (11)	378 (11)	274 (11)	317 (15)	359 (18)	268 (15)	308 (17)	348 (19)	251 (19)	291 (19)	331 (21)	237 (20)	271 (21)	307 (23)	225 (23)	262 (24)	298 (25)	227 (29)	245 (29)	264 (27)
750	Liquid pressure (subcool)	279 (11)	317 (11)	357 (11)	253 (8)	297 (13)	341 (19)	253 (15)	293 (18)	333 (20)	239 (18)	279 (19)	319 (20)	227 (19)	261 (21)	297 (23)	217 (21)	252 (23)	288 (25)	213 (30)	233 (27)	252 (24)
-	Suction pressure	135	136	137	109	109	110	97	97	98	80	82	84	60	61.16	62	51	52	53	41	41	42

Table 28: 2 ton heating charging chart for XA(F,H)*30C and JH(E,V)T*24C in upflow and horizontal left

CFM	Ambient temperature (°F)	60			47			40			30			17			10			0		
	Indoor temperature (°F)	60	70	80	60	70	80	60	70	80	60	70	80	60	70	80	60	70	80	60	70	80
600	Liquid pressure (subcool)	363 (28)	410 (30)	458 (31)	336 (32)	383 (34)	430 (36)	323 (35)	349 (35)	375 (35)	306 (37)	354 (39)	402 (41)	285 (40)	330 (42)	375 (44)	272 (40)	313 (41)	355 (43)	251 (43)	291 (45)	332 (48)
800	Liquid pressure (subcool)	330 (26)	375 (27)	420 (29)	307 (29)	344 (30)	397 (33)	297 (31)	331 (33)	365 (34)	283 (33)	329 (36)	376 (38)	266 (36)	304 (37)	353 (40)	256 (36)	297 (38)	339 (41)	237 (39)	278 (42)	318 (45)
1000	Liquid pressure (subcool)	297 (23)	339 (25)	382 (26)	278 (26)	321 (28)	365 (30)	272 (28)	313 (31)	354 (34)	261 (30)	305 (33)	349 (35)	247 (31)	289 (34)	330 (37)	239 (32)	281 (35)	323 (38)	224 (34)	264 (38)	304 (41)
-	Suction pressure	127	128	129	102	102	104	89	82	76	73	74	76	57	58	59	49	50	51	39	39	40

Table 29: 2 ton heating charging chart for XA(F,H)*30C and JH(E,V)T*24C in downflow and horizontal right

CFM	Ambient temperature (°F)	60			47			40			30			17			10			0		
	Indoor temperature (°F)	60	70	80	60	70	80	60	70	80	60	70	80	60	70	80	60	70	80	60	70	80
600	Liquid pressure (subcool)	371 (17)	419 (18)	468 (18)	343 (19)	391 (20)	439 (21)	330 (21)	356 (21)	383 (21)	312 (22)	361 (23)	410 (24)	278 (27)	322 (28)	366 (30)	266 (27)	306 (28)	347 (29)	245 (29)	284 (30)	324 (33)
800	Liquid pressure (subcool)	338 (16)	384 (17)	430 (18)	314 (18)	352 (19)	407 (21)	304 (19)	339 (21)	374 (21)	290 (21)	337 (23)	385 (24)	263 (23)	300 (24)	349 (26)	253 (23)	294 (25)	335 (27)	234 (25)	275 (27)	314 (29)
1000	Liquid pressure (subcool)	305 (13)	348 (14)	392 (15)	285 (15)	330 (16)	374 (17)	279 (16)	321 (18)	363 (20)	268 (17)	313 (19)	358 (20)	247 (21)	288 (23)	330 (25)	239 (22)	281 (24)	323 (26)	224 (23)	264 (26)	304 (28)
-	Suction pressure	127	128	129	102	102	104	89	82	76	73	74	76	54	55	56	47	47	48	37	37	38

Table 30: 2.5 ton heating charging chart for XA(F,H)*36D and JH(E,V)T*(30,36)D in upflow and horizontal left

CFM	Ambient temperature (°F)	60			47			40			30			17			10			0		
	Indoor temperature (°F)	60	70	80	60	70	80	60	70	80	60	70	80	60	70	80	60	70	80	60	70	80
750	Liquid pressure (subcool)	329 (16)	372 (15)	415 (14)	306 (14)	341 (14)	392 (15)	295 (15)	333 (17)	371 (20)	270 (20)	315 (19)	359 (17)	258 (19)	292 (22)	338 (24)	249 (23)	288 (24)	328 (26)	235 (24)	273 (26)	312 (27)
1000	Liquid pressure (subcool)	290 (15)	331 (14)	372 (14)	273 (12)	310 (13)	352 (12)	265 (14)	301 (16)	338 (18)	247 (17)	286 (17)	326 (17)	236 (15)	273 (19)	311 (17)	227 (16)	265 (17)	303 (18)	216 (17)	253 (18)	289 (19)
1250	Liquid pressure (subcool)	264 (16)	304 (16)	344 (15)	251 (15)	291 (13)	327 (13)	244 (13)	282 (16)	318 (17)	232 (16)	270 (17)	307 (19)	225 (17)	262 (18)	298 (19)	216 (20)	253 (21)	291 (21)	207 (19)	243 (20)	280 (21)
-	Suction pressure	110	114	118	98	99	101	88	85	83	69	71	72	56	57	58	49	49	50	41	41	42

Table 31: 2.5 ton heating charging chart for XA(F,H)*36D and JH(E,V)T*(30,36)D in downflow and horizontal right

CFM	Ambient temperature (°F)	60			47			40			30			17			10			0		
	Indoor temperature (°F)	60	70	80	60	70	80	60	70	80	60	70	80	60	70	80	60	70	80	60	70	80
750	Liquid pressure (subcool)	333 (15)	376 (14)	419 (13)	310 (13)	344 (13)	396 (14)	298 (14)	337 (16)	375 (18)	273 (18)	318 (17)	363 (16)	261 (21)	296 (23)	342 (26)	252 (25)	292 (26)	332 (28)	238 (26)	277 (28)	316 (29)
1000	Liquid pressure (subcool)	296 (13)	337 (12)	378 (12)	277 (11)	315 (12)	358 (11)	269 (12)	307 (14)	344 (17)	251 (15)	292 (15)	332 (15)	240 (17)	279 (22)	317 (20)	231 (19)	270 (20)	309 (21)	220 (20)	258 (21)	294 (22)
1250	Liquid pressure (subcool)	270 (14)	310 (14)	352 (13)	257 (13)	298 (12)	334 (12)	250 (12)	288 (14)	325 (15)	237 (14)	276 (15)	314 (18)	229 (18)	267 (19)	303 (19)	220 (21)	258 (22)	296 (22)	211 (19)	247 (21)	285 (22)
-	Suction pressure	112	116	120	100	101	103	89	86	84	70	72	73	56	57	58	49	49	50	41	41	42

Table 32: 3 ton heating charging chart for XA(F,H)*36D and JH(E,V)T*36D in upflow and horizontal left

CFM	Ambient temperature (°F)	60			47			40			30			17			10			0		
	Indoor temperature (°F)	60	70	80	60	70	80	60	70	80	60	70	80	60	70	80	60	70	80	60	70	80
950	Liquid pressure (subcool)	350 (30)	397 (32)	442 (34)	324 (35)	370 (37)	414 (39)	308 (38)	354 (41)	401 (43)	291 (38)	337 (41)	382 (45)	276 (40)	316 (44)	356 (47)	264 (42)	305 (45)	347 (48)	241 (39)	281 (42)	321 (44)
1200	Liquid pressure (subcool)	325 (30)	361 (34)	417 (36)	305 (36)	340 (34)	394 (40)	293 (38)	328 (42)	383 (45)	277 (39)	311 (43)	365 (46)	262 (42)	296 (42)	345 (49)	251 (45)	286 (48)	334 (52)	233 (41)	267 (45)	313 (48)
1450	Liquid pressure (subcool)	293 (26)	338 (28)	382 (30)	279 (30)	322 (32)	365 (34)	270 (31)	314 (34)	358 (37)	255 (33)	297 (36)	339 (40)	243 (36)	284 (40)	326 (43)	234 (38)	273 (41)	313 (45)	220 (35)	259 (38)	298 (41)
-	Suction pressure	123	124	124	98	99	100	84	85	86	71	70	70	54	54	54	45	46	47	36	37	38

Table 33: 3 ton heating charging chart for XA(F,H)*36D and JH(E,V)T*36D in downflow and horizontal right

CFM	Ambient temperature (°F)	60			47			40			30			17			10			0		
	Indoor temperature (°F)	60	70	80	60	70	80	60	70	80	60	70	80	60	70	80	60	70	80	60	70	80
950	Liquid pressure (subcool)	371 (33)	421 (35)	469 (37)	344 (39)	392 (40)	439 (43)	326 (42)	376 (45)	425 (47)	309 (42)	357 (45)	405 (50)	293 (44)	335 (47)	378 (52)	280 (46)	324 (49)	369 (53)	255 (43)	298 (46)	340 (48)
1201	Liquid pressure (subcool)	346 (34)	384 (37)	444 (40)	325 (40)	362 (38)	419 (45)	312 (42)	350 (46)	408 (50)	295 (44)	332 (47)	389 (51)	280 (46)	316 (46)	368 (54)	268 (49)	306 (52)	357 (56)	249 (45)	285 (49)	334 (52)
1450	Liquid pressure (subcool)	311 (29)	359 (31)	406 (33)	297 (33)	342 (35)	388 (38)	287 (35)	334 (38)	380 (42)	271 (37)	316 (40)	360 (44)	258 (38)	302 (42)	347 (45)	249 (41)	291 (44)	333 (48)	234 (37)	276 (41)	317 (44)
-	Suction pressure	123	124	124	98	99	100	84	85	86	71	70	70	54	54	54	46	47	48	36	37	38

Table 34: 3.5 ton heating charging chart for XA(F,H)*48F and JH(E,V)T*42F in upflow and horizontal left

CFM	Ambient temperature (°F)	60			47			40			30			17			10			0		
	Indoor temperature (°F)	60	70	80	60	70	80	60	70	80	60	70	80	60	70	80	60	70	80	60	70	80
1150	Liquid pressure (subcool)	371 (35)	420 (35)	468 (34)	343 (34)	391 (34)	438 (34)	327 (33)	373 (33)	419 (33)	313 (33)	358 (34)	403 (35)	293 (35)	336 (36)	379 (36)	271 (32)	316 (33)	360 (34)	246 (28)	297 (32)	347 (36)
1375	Liquid pressure (subcool)	349 (34)	397 (34)	443 (33)	324 (33)	366 (32)	416 (33)	311 (32)	356 (32)	401 (32)	295 (31)	340 (32)	385 (33)	279 (33)	309 (31)	365 (34)	261 (30)	303 (30)	344 (31)	243 (28)	290 (31)	336 (34)
1650	Liquid pressure (subcool)	322 (33)	368 (33)	413 (32)	301 (31)	346 (31)	390 (31)	291 (30)	335 (30)	378 (30)	272 (28)	317 (29)	362 (30)	262 (30)	304 (30)	347 (31)	249 (27)	287 (27)	324 (27)	239 (28)	281 (30)	322 (32)
-	Suction pressure	119	122	125	101	101	103	89	91	93	75	75	75	57	56	58	49	49	50	40	40	41

Table 35: 3.5 ton heating charging chart for XA(F,H)*48F and JH(E,V)T*42F in downflow and horizontal right

CFM	Ambient temperature (°F)	60			47			40			30			17			10			0		
	Indoor temperature (°F)	60	70	80	60	70	80	60	70	80	60	70	80	60	70	80	60	70	80	60	70	80
1150	Liquid pressure (subcool)	394 (39)	446 (39)	497 (38)	364 (38)	415 (38)	465 (38)	347 (37)	396 (37)	445 (37)	332 (37)	380 (38)	428 (39)	291 (33)	334 (34)	376 (34)	269 (30)	314 (31)	358 (32)	244 (26)	295 (30)	345 (34)
1400	Liquid pressure (subcool)	369 (38)	419 (38)	469 (37)	342 (37)	389 (36)	440 (37)	328 (36)	376 (36)	424 (36)	311 (35)	359 (36)	407 (37)	294 (35)	327 (33)	384 (36)	275 (32)	318 (32)	362 (33)	257 (30)	306 (33)	354 (36)
1650	Liquid pressure (subcool)	346 (38)	395 (38)	443 (37)	323 (35)	371 (35)	418 (35)	312 (34)	359 (34)	406 (34)	292 (32)	340 (33)	388 (34)	273 (31)	317 (32)	362 (32)	260 (28)	299 (28)	338 (28)	249 (29)	293 (31)	336 (33)
-	Suction pressure	119	122	125	101	101	103	89	91	93	75	75	75	58	57	59	50	50	51	41	41	42

Table 36: 3.5 ton heating charging chart for XA(F,H)*60G and JH(E,V)T*48G in upflow and horizontal left

CFM	Ambient temperature (°F)	60			47			40			30			17			10			0		
	Indoor temperature (°F)	60	70	80	60	70	80	60	70	80	60	70	80	60	70	80	60	70	80	60	70	80
1150	Liquid pressure (subcool)	341 (22)	386 (21)	430 (21)	315 (21)	359 (21)	403 (21)	301 (20)	343 (20)	385 (20)	288 (20)	329 (21)	371 (22)	262 (22)	301 (22)	339 (23)	243 (19)	283 (20)	322 (21)	225 (19)	272 (23)	318 (27)
1400	Liquid pressure (subcool)	319 (22)	363 (21)	406 (21)	297 (20)	334 (20)	382 (20)	285 (19)	326 (19)	367 (19)	270 (18)	311 (19)	353 (20)	251 (21)	279 (17)	329 (22)	236 (18)	273 (19)	310 (19)	222 (19)	265 (22)	307 (25)
1650	Liquid pressure (subcool)	297 (21)	340 (21)	381 (20)	278 (19)	319 (19)	360 (19)	269 (18)	309 (18)	349 (18)	251 (16)	293 (17)	334 (18)	240 (20)	279 (20)	318 (21)	228 (17)	263 (17)	297 (17)	219 (19)	257 (21)	295 (23)
-	Suction pressure	115	118	121	98	98	100	86	88	90	73	73	73	57	57	58	49	49	50	39	39	40

Table 37: 3.5 ton heating charging chart for XA(F,H)*60G and JH(E,V)T*48G in downflow and horizontal right

CFM	Ambient temperature (°F)	60			47			40			30			17			10			0		
	Indoor temperature (°F)	60	70	80	60	70	80	60	70	80	60	70	80	60	70	80	60	70	80	60	70	80
1150	Liquid pressure (subcool)	377 (35)	426 (33)	475 (33)	348 (33)	397 (33)	445 (33)	333 (32)	379 (32)	425 (32)	318 (32)	363 (33)	410 (35)	285 (31)	328 (31)	369 (32)	265 (27)	308 (28)	351 (30)	245 (27)	296 (32)	346 (38)
1400	Liquid pressure (subcool)	355 (35)	404 (33)	452 (33)	330 (31)	371 (31)	425 (31)	317 (30)	363 (30)	408 (30)	300 (28)	346 (30)	393 (31)	279 (35)	310 (28)	366 (36)	262 (30)	304 (31)	345 (31)	247 (31)	295 (36)	341 (41)
1650	Liquid pressure (subcool)	328 (32)	375 (32)	421 (31)	307 (29)	352 (29)	397 (29)	297 (28)	341 (28)	385 (28)	277 (25)	323 (26)	369 (28)	258 (26)	300 (26)	342 (28)	245 (22)	283 (22)	319 (22)	235 (25)	276 (28)	317 (30)
-	Suction pressure	117	120	123	100	100	102	88	90	92	74	74	74	57	57	58	49	49	50	39	39	40

Table 38: 4 ton heating charging chart for XA(F,H)*60G and JH(E,V)T*48G in upflow and horizontal left

CFM	Ambient temperature (°F)	60			47			40			30			17			10			0		
	Indoor temperature (°F)	60	70	80	60	70	80	60	70	80	60	70	80	60	70	80	60	70	80	60	70	80
1350	Liquid pressure (subcool)	333 (16)	375 (17)	417 (17)	310 (20)	353 (21)	396 (22)	298 (22)	341 (24)	385 (26)	282 (26)	325 (28)	369 (30)	263 (28)	304 (29)	344 (31)	256 (29)	296 (31)	335 (34)	240 (32)	279 (34)	319 (37)
1600	Liquid pressure (subcool)	314 (16)	355 (17)	397 (17)	294 (19)	334 (22)	378 (22)	281 (21)	325 (23)	369 (25)	271 (24)	312 (27)	353 (29)	255 (28)	291 (28)	334 (32)	248 (29)	288 (31)	327 (34)	234 (31)	272 (33)	312 (36)
1850	Liquid pressure (subcool)	294 (15)	335 (16)	376 (16)	278 (18)	322 (19)	360 (21)	264 (20)	308 (22)	353 (24)	259 (22)	298 (25)	337 (28)	247 (27)	285 (29)	324 (32)	240 (28)	280 (31)	319 (33)	227 (30)	265 (32)	304 (35)
-	Suction pressure	120	122	124	96	97	99	84	86	89	72	71	71	55	56	55	48	48	49	36	37	38

Table 39: 4 ton heating charging chart for XA(F,H)*60G and JH(E,V)T*48G in downflow and horizontal right

CFM	Ambient temperature (°F)	60			47			40			30			17			10			0		
	Indoor temperature (°F)	60	70	80	60	70	80	60	70	80	60	70	80	60	70	80	60	70	80	60	70	80
1350	Liquid pressure (subcool)	329 (24)	370 (25)	412 (25)	306 (30)	348 (31)	391 (33)	294 (33)	337 (36)	380 (39)	278 (39)	321 (42)	364 (45)	256 (31)	296 (32)	335 (34)	249 (32)	288 (34)	326 (37)	234 (35)	271 (37)	310 (41)
1600	Liquid pressure (subcool)	313 (22)	354 (23)	396 (23)	293 (26)	333 (30)	377 (30)	280 (28)	324 (31)	368 (34)	270 (32)	311 (36)	352 (39)	251 (30)	287 (30)	329 (34)	244 (31)	284 (33)	322 (37)	231 (33)	268 (35)	307 (39)
1850	Liquid pressure (subcool)	294 (22)	335 (24)	376 (24)	278 (27)	322 (28)	360 (31)	264 (30)	308 (33)	353 (36)	259 (33)	298 (37)	337 (42)	243 (27)	281 (29)	319 (32)	237 (28)	276 (31)	314 (33)	224 (30)	261 (32)	300 (35)
-	Suction pressure	136	138	140	109	110	112	95	97	101	82	80	80	62	63	62	54	54	55	40	42	43

Table 40: 4 ton heating charging chart for JHET*60H in upflow

CFM	Ambient temperature (°F)	60			47			40			30			17			10			0		
	Indoor temperature (°F)	60	70	80	60	70	80	60	70	80	60	70	80	60	70	80	60	70	80	60	70	80
1350	Liquid pressure (subcool)	333 (16)	375 (17)	417 (17)	310 (20)	353 (21)	396 (22)	298 (22)	341 (24)	385 (26)	282 (26)	325 (28)	369 (30)	263 (28)	304 (29)	344 (31)	256 (29)	296 (31)	335 (34)	242 (32)	281 (35)	321 (37)
1665	Liquid pressure (subcool)	310 (15)	352 (16)	394 (16)	292 (19)	330 (21)	376 (21)	278 (20)	322 (23)	367 (25)	269 (23)	310 (26)	351 (29)	253 (27)	291 (28)	331 (32)	246 (28)	286 (30)	325 (33)	234 (31)	272 (34)	312 (36)
1850	Liquid pressure (subcool)	297 (15)	338 (16)	380 (16)	281 (18)	322 (19)	364 (21)	267 (19)	311 (22)	356 (24)	262 (22)	301 (25)	340 (28)	247 (26)	285 (29)	324 (32)	240 (28)	280 (30)	319 (33)	229 (30)	267 (33)	306 (35)
-	Suction pressure	119	121	123	95	97	98	83	85	88	72	71	71	56	56	56	49	49	50	36	37	38

Table 41: 5 ton heating charging chart for XA(F,H)*60H and JH(E,V)T*60H in upflow and horizontal left

CFM	Ambient temperature (°F)	60			47			40			30			17			10			0		
	Indoor temperature (°F)	60	70	80	60	70	80	60	70	80	60	70	80	60	70	80	60	70	80	60	70	80
1500	Liquid pressure (subcool)	327 (10)	368 (10)	410 (9)	307 (13)	349 (14)	391 (14)	296 (16)	339 (16)	383 (17)	278 (18)	323 (19)	367 (20)	260 (20)	299 (20)	337 (21)	249 (21)	288 (21)	326 (22)	241 (24)	279 (24)	316 (25)
1750	Liquid pressure (subcool)	308 (11)	349 (10)	391 (9)	291 (13)	331 (13)	375 (14)	281 (15)	324 (16)	368 (17)	269 (18)	311 (19)	352 (20)	251 (19)	289 (20)	330 (21)	242 (20)	281 (21)	318 (22)	234 (23)	272 (23)	309 (24)
2000	Liquid pressure (subcool)	289 (11)	330 (10)	371 (9)	275 (13)	317 (13)	359 (13)	266 (14)	309 (15)	352 (16)	259 (17)	298 (18)	337 (19)	242 (18)	282 (19)	322 (20)	235 (19)	273 (20)	310 (21)	227 (22)	265 (22)	302 (23)
-	Suction pressure	115	118	120	95	96	98	82	84	86	69	69	69	52	53	53	44	45	46	37	37	38

Table 42: 5 ton heating charging chart for XA(F,H)*60H and JH(E,V)T*60H in downflow and horizontal right

CFM	Ambient temperature (°F)	60			47			40			30			17			10			0		
	Indoor temperature (°F)	60	70	80	60	70	80	60	70	80	60	70	80	60	70	80	60	70	80	60	70	80
1500	Liquid pressure (subcool)	390 (28)	439 (28)	489 (25)	366 (36)	416 (39)	466 (39)	353 (44)	404 (44)	456 (47)	331 (50)	385 (53)	437 (55)	308 (42)	355 (42)	400 (44)	295 (44)	342 (44)	387 (46)	286 (50)	331 (50)	375 (52)
1750	Liquid pressure (subcool)	365 (31)	414 (28)	463 (25)	345 (36)	392 (36)	445 (39)	333 (42)	384 (45)	436 (48)	319 (51)	369 (53)	417 (56)	290 (36)	333 (38)	381 (40)	279 (38)	324 (40)	367 (42)	270 (44)	314 (44)	357 (45)
2000	Liquid pressure (subcool)	342 (29)	390 (27)	439 (24)	325 (35)	375 (35)	424 (35)	314 (37)	365 (40)	416 (43)	306 (45)	352 (48)	398 (51)	278 (34)	324 (36)	370 (38)	270 (36)	313 (38)	356 (40)	261 (42)	304 (42)	347 (44)
-	Suction pressure	113	116	118	94	95	97	81	83	85	68	68	68	48	49	49	41	42	43	34	34	35

Table 43: 5 ton heating charging chart for XA(F,H)*60J and JH(E,V)T*60J in upflow and horizontal left

CFM	Ambient temperature (°F)	60			47			40			30			17			10			0		
	Indoor temperature (°F)	60	70	80	60	70	80	60	70	80	60	70	80	60	70	80	60	70	80	60	70	80
1500	Liquid pressure (subcool)	317 (10)	357 (9)	397 (9)	295 (13)	336 (13)	378 (13)	285 (16)	326 (17)	367 (17)	271 (18)	309 (19)	348 (20)	254 (20)	291 (21)	328 (21)	245 (21)	283 (21)	320 (22)	235 (23)	272 (23)	310 (23)
1750	Liquid pressure (subcool)	298 (10)	338 (9)	377 (9)	281 (13)	319 (12)	362 (13)	273 (15)	312 (16)	352 (16)	261 (17)	298 (18)	337 (19)	245 (19)	282 (20)	320 (21)	237 (20)	274 (20)	311 (21)	228 (22)	265 (22)	303 (22)
2000	Liquid pressure (subcool)	279 (10)	318 (9)	357 (8)	266 (13)	306 (12)	345 (12)	261 (14)	298 (15)	336 (15)	250 (16)	287 (17)	325 (17)	236 (18)	273 (19)	311 (20)	229 (19)	265 (19)	302 (20)	221 (20)	258 (21)	295 (21)
-	Suction pressure	114	116	118	94	95	96	82	82	82	68	68	67	52	52	52	44	44	45	36	37	38

Table 44: 5 ton heating charging chart for XA(F,H)*60J and JH(E,V)T*60J in downflow and horizontal right

CFM	Ambient temperature (°F)	60			47			40			30			17			10			0		
	Indoor temperature (°F)	60	70	80	60	70	80	60	70	80	60	70	80	60	70	80	60	70	80	60	70	80
1500	Liquid pressure (subcool)	319 (15)	359 (14)	399 (14)	297 (20)	338 (20)	380 (20)	287 (24)	328 (26)	369 (26)	272 (27)	311 (29)	350 (30)	259 (25)	297 (27)	334 (27)	250 (27)	289 (27)	326 (28)	240 (29)	277 (29)	316 (29)
1750	Liquid pressure (subcool)	299 (15)	339 (14)	378 (14)	282 (20)	320 (18)	363 (20)	274 (23)	313 (25)	353 (25)	262 (26)	299 (28)	338 (29)	247 (24)	285 (25)	323 (26)	239 (25)	276 (25)	314 (26)	230 (28)	267 (28)	306 (28)
2000	Liquid pressure (subcool)	280 (15)	319 (13)	358 (12)	267 (19)	307 (18)	346 (18)	262 (21)	299 (22)	337 (22)	251 (24)	288 (25)	326 (25)	237 (22)	274 (24)	312 (25)	230 (24)	266 (24)	303 (25)	222 (25)	259 (26)	296 (26)
-	Suction pressure	113	115	117	93	94	95	81	81	81	67	67	66	51	51	51	43	43	44	35	36	37

Electrical connections

General information and grounding

The control box cover is held in place with three screws, one screw in each lower corner and one screw at the top center post. The control box can swing open by removing the screw from the center of each side of the control box and allowing the control box to lower an inch or so into a pivotal position.

NOTICE

Flexible electrical wiring must be installed in order to use the swing away function of the control box. Rigid type electrical connections require the wiring to be disconnected in order to swing the control box open.

The control box can then swing open from the left by rotating on the right side pivots for easy service of refrigeration components. If no wiring is in or routed through the control box, it can be removed from the unit by lifting slightly, tilting the top hinge out, and lifting the bottom hinge out. During the installation, it is recommended to route the low voltage wiring for the thermostat along the unit high voltage wiring to help facilitate the swing away feature of the control box. See Figure 9.

Check the electrical supply to be sure that it meets the values specified on the unit nameplate and wiring label. Power wiring, control (low voltage) wiring, disconnect switches and over current protection must be supplied by the installer. Wire size should be sized per NEC requirements.

Figure 9: Outdoor unit swing away control box

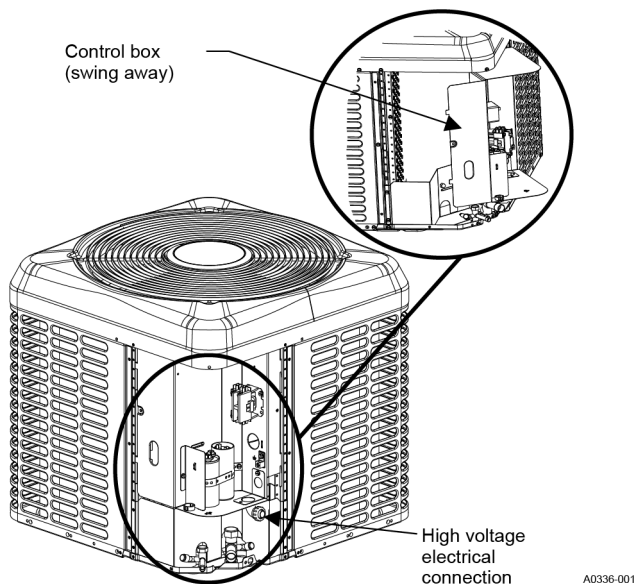

CAUTION

All field wiring must use copper conductors only and be in accordance with Local, National, Fire, Safety and Electrical Codes. This unit must be grounded with a separate ground wire in accordance with the above codes.

The complete connection diagram and schematic wiring label is located on the inside surface of the unit service access panel.

Field connections power wiring

1. Install the correct size weatherproof disconnect switch outdoors and within sight of the unit.
2. Remove the screws at the top and sides of the corner cover. Slide the control box cover down and remove from unit.
3. Run power wiring from the disconnect switch to the unit.
4. Route wires from disconnect through power wiring exit provided and into the unit control box correct location as shown in Figure 10, Figure 11, or Figure 12.
5. Install the correct size time-delay fuses or circuit breaker, and make the power supply connections.

Field connections control wiring

1. Route low voltage wiring into bottom of control box correct location as shown in Figure 10, Figure 11, and Figure 12. Connect low voltage wiring to the appropriate connections. Reference Figure 13 to Figure 20 depending on the application.
2. The complete connection diagram and schematic wiring label is located on the inside surface of the unit service access panel.
3. Replace the control box cover removed in Step 2 of the [Field connections power wiring](#) procedure.
4. All field wiring to be in accordance with national electrical codes (NEC) and local-city codes.

NOTICE

A Start Assist Kit is available and recommended for long lineset applications or in areas of known low voltage problems.

5. Mount the thermostat about 5 ft above the floor, where it will be exposed to normal room air circulation. Do not place it on an outside wall or where it is exposed to the radiant effect from exposed glass or appliances, drafts from outside doors or supply air grilles.
6. Route the 24 V control wiring (NEC Class 2) from the outdoor unit to the indoor unit and thermostat.

NOTICE

To eliminate erratic operation, seal the hole in the wall at the thermostat with permagum or equivalent to prevent air drafts affecting the operation of in the thermostat.

Figure 10: Outdoor unit control box (208/230 V single-phase 30, 36, 42, 48, and 60 models only)

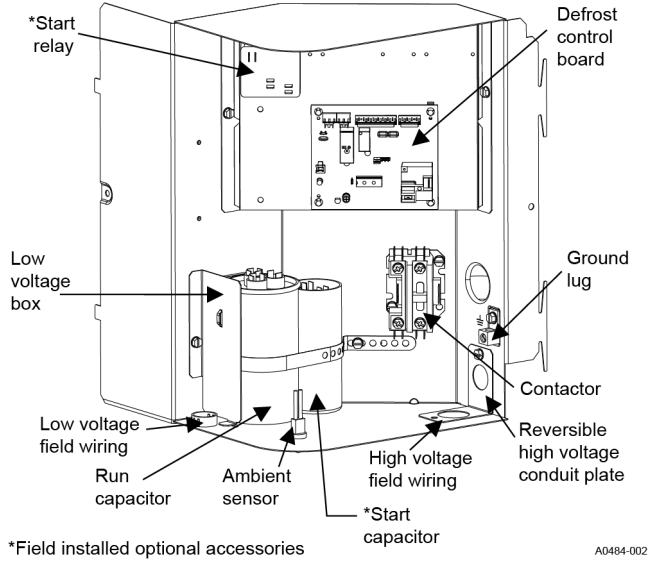

Figure 11: Outdoor unit control box (208/230 V and 460 V three-phase)

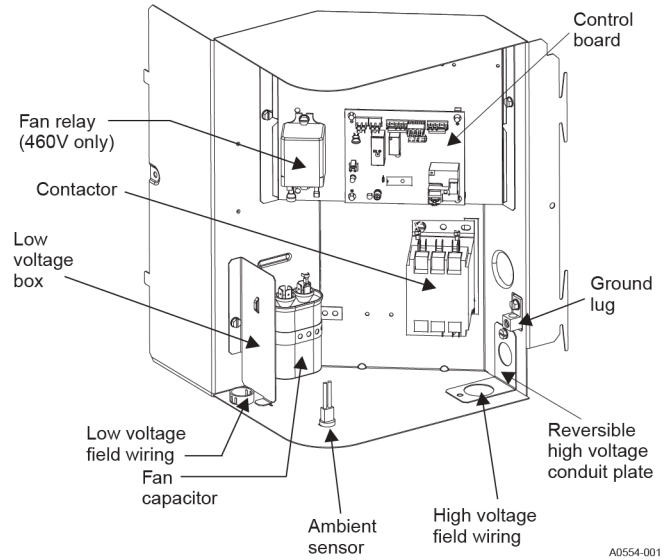
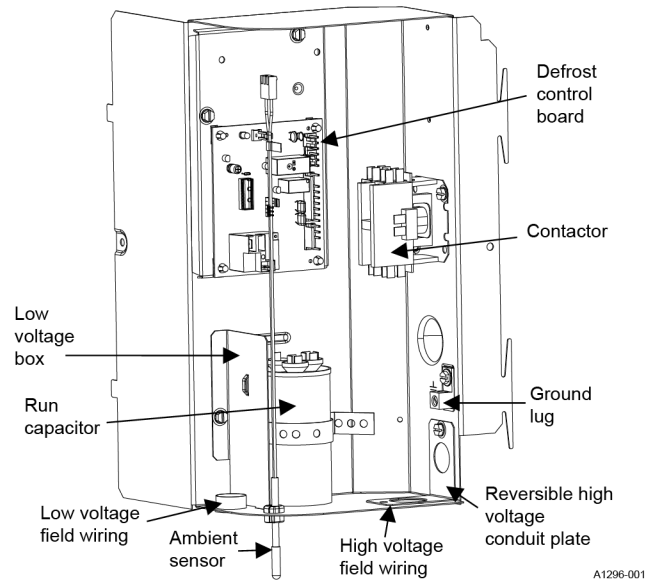
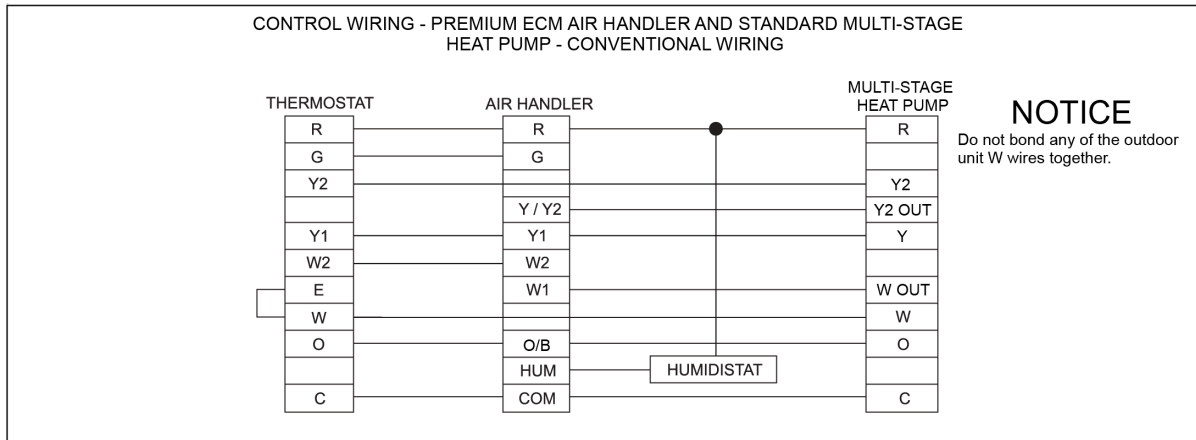

Figure 12: Outdoor unit control box (208/230 V single-phase 18 and 24 models only)



Control wiring diagrams

Figure 13: Standard MS HP - Premium ECM AHU



A1748-001

Figure 14: Standard MS HP - Premium ECM Gas Furnace

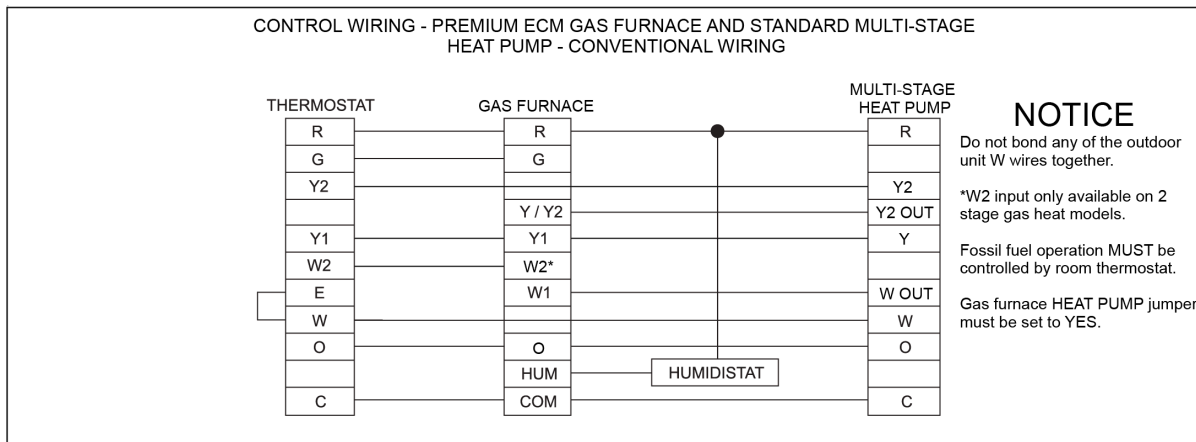

A1749-001

Figure 15: Standard MS HP - Standard ECM AHU

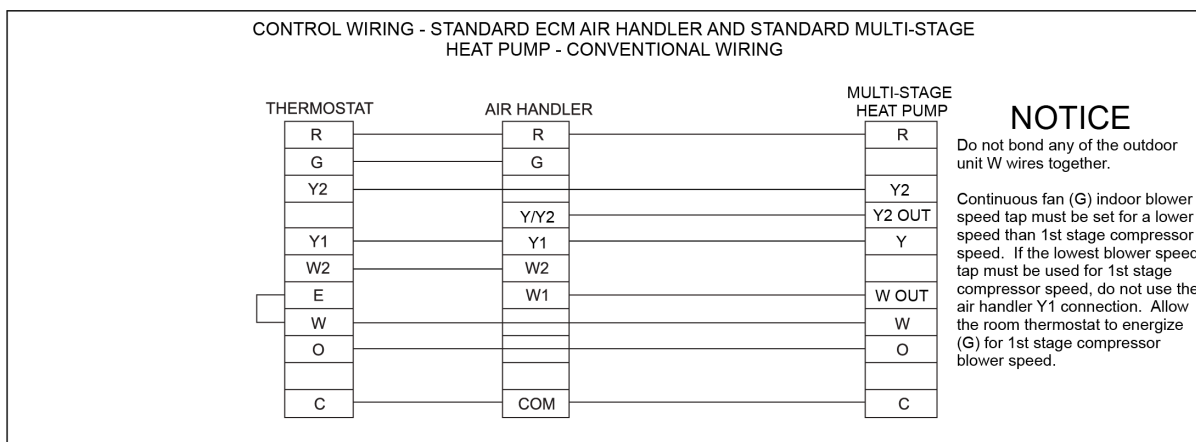

A1750-002

Figure 16: Standard MS HP - Standard ECM Gas Furnace

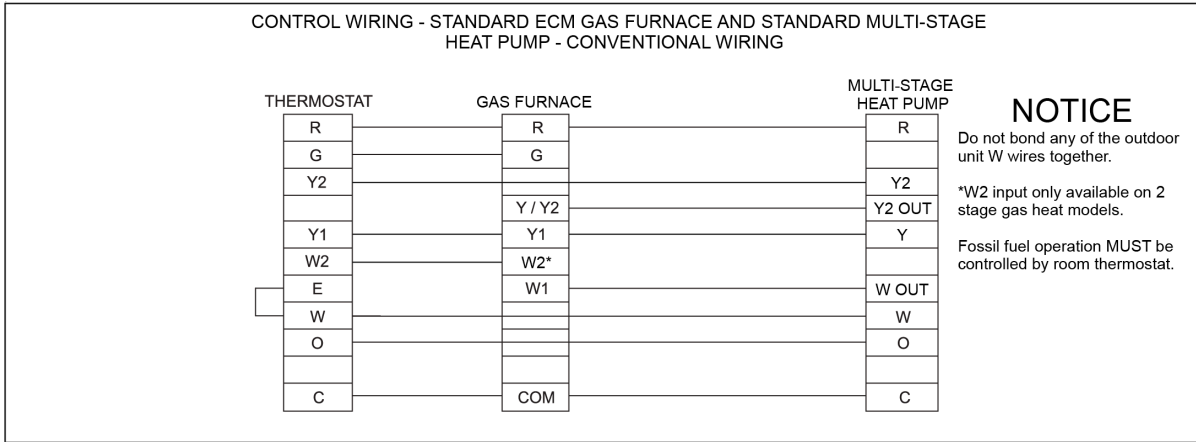

A1751-001

Figure 17: Standard SS HP - Premium ECM AHU

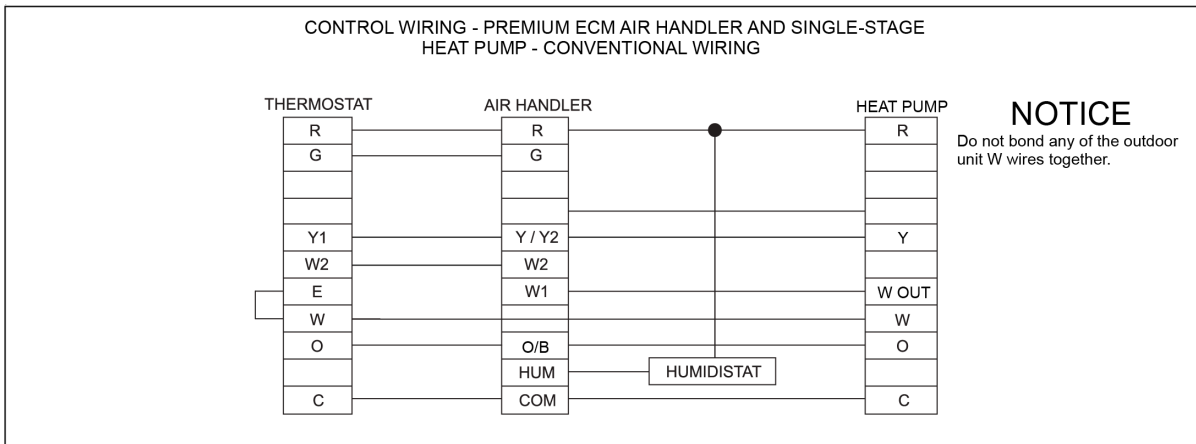

A1752-001

Figure 18: Standard SS HP - Premium ECM Gas Furnace

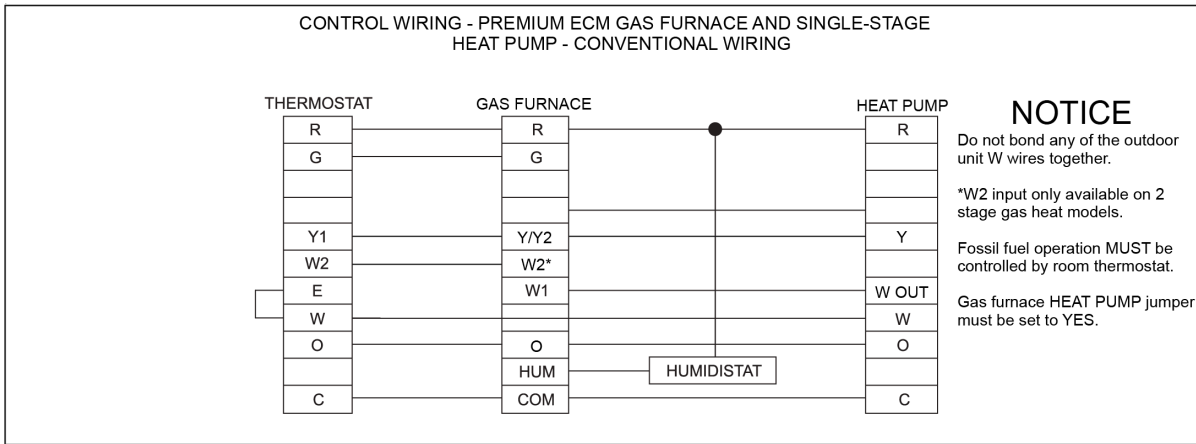

A1753-001

Figure 19: Standard SS HP - Standard ECM AHU

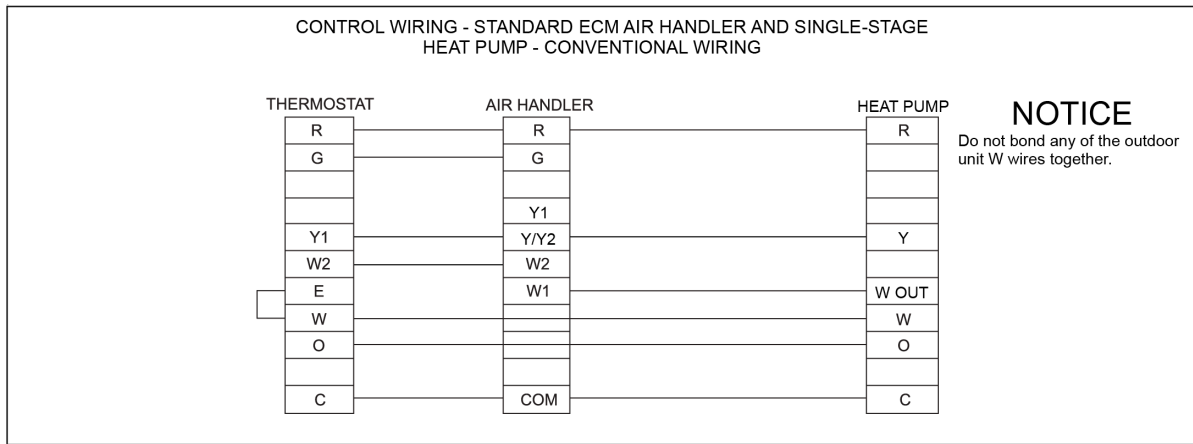
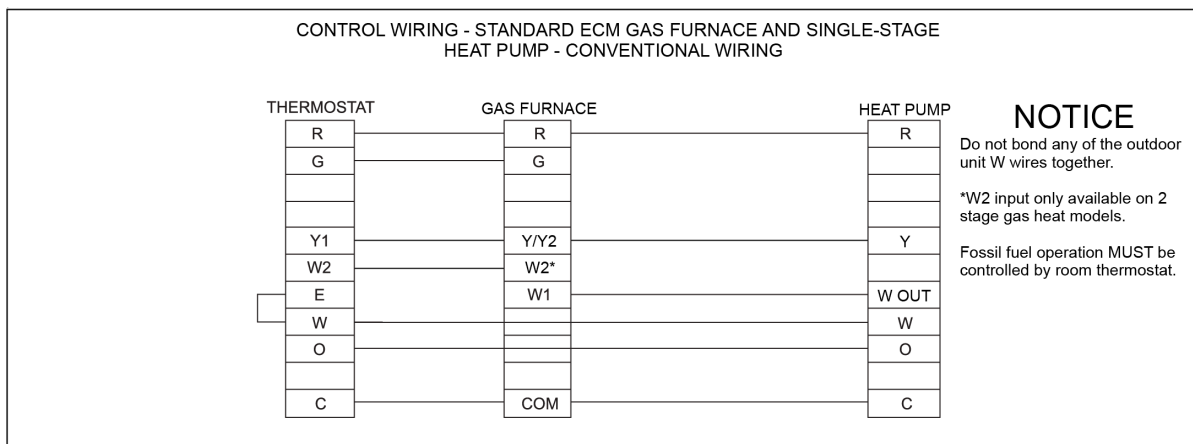

Figure 20: Standard SS HP - Standard ECM Gas Furnace



Dehumidification control (typical)

The indoor unit *Installation Manual* instructions for the air handler or furnace describe the interface with the outdoor heat pump. A dehumidification control accessory SI-2HU16700124 may be used with variable speed air handlers or furnaces in high humidity areas. This control works with the variable speed indoor unit to provide cooling at a reduced air flow, lowering evaporator temperature and increasing latent capacity. The humidistat in this control opens the humidistat contacts as the humidity increases. Installation instructions are packaged with the accessory. Prior to the installation of the dehumidification control, the humidistat jumper must be set to **YES** on the indoor variable speed air handler or furnace control board.

During cooling, if the relative humidity in the space is higher than the desired set point of the dehumidification control, the variable speed blower motor will operate at lower speed until the dehumidification control is satisfied. A 40-60% relative humidity level is recommended to achieve optimum comfort.

If a dehumidification control is installed, it is recommended that a minimum air flow of 325 CFM/ton be supplied at all times.

Indoor cubic feet per minute (CFM) settings (typical)

Refer to the indoor unit *Installation Manual* instructions for the air handler or furnace interface with the outdoor heat pump. Refer to the outdoor *Technical Guide* for the recommended indoor airflow settings of each specific heat pump. For the system to operate correctly, ensure that the indoor CFM selection is correct.

System start-up

Energize crankcase heater (where applicable)

About this task:

In order to energize the crankcase heater, set the indoor cooling thermostat to the **OFF** position. Close the line power disconnect to the unit. The outdoor unit (where applicable) has a CCH thermostat that opens at 45°F and closes at 35°F outdoor ambient temperature.

NOTICE

An attempt to start the compressor without at least 8 h of crankcase heat may damage the compressor. Installation of an accessory crankcase heater is required if not factory installed for installations over the maximum allowable line length.

With power to unit and thermostat in cooling position:

1. In the cooling cycle, discharge gas is pumped to the outdoor coil which is the condenser. The indoor coil is the evaporator.
2. If the fan switch is in **ON** position, a circuit is made through the blower relay to provide continuous blower operation.
3. With fan switch in **AUTO** position, a circuit is made from thermostat cooling contact through blower relay to provide blower operation.
4. The system will cycle with thermostat demand to provide cooling as needed.

Table 45: TEST input functionality with Y

Duration of connection (s)	Control behavior with thermostat signals present
< 2	No response
2 to 5	Bypass ASCD (Reduce timer to zero immediately). If Y1 is present and high-pressure switch is closed, contactor is energized. If Y2 is also present, second stage output (M2) will also be energized. Clear pressure switch lockout and reset the 6 h PS timer.
> 5	Initiate defrost cycle ignoring the COIL temp and record that defrost cycle was initiated by TEST short. Energize Wout and begin defrost cycle immediately upon expiration of timer.
Test pin short removed	Terminate defrost as normal.
Test pin short not removed	Continue defrost cycle until TEST connection removed.

System operation

Anti short-cycle delay

The control includes a 5 min anti-short-cycle delay (ASCD) timer to prevent the compressor from short-cycling after a power or thermostat signal interruption. The ASCD timer is applied when the control is first powered from the indoor unit thermostat and immediately following the completion of a compressor run cycle. The compressor and the outdoor fan will not operate during the 5 min that the timer is active.

The ASCD timer can be bypassed by shorting the TEST terminals for 3 s while the thermostat is calling for compressor operation (Y input signal energized).

Low voltage detection

The control monitors the transformer secondary (24 VAC) voltage and provides low voltage protection for the heat pump and its components. In particular, the control prevents contactor chatter during low voltage conditions. If the voltage drops below approximately 19 VAC, the control will continue to energize any relays that are already energized but will not energize any additional relays until the voltage level increases. If the voltage drops below approximately 16 VAC, the control will immediately de-energize the relay outputs and will not energize any relays until the voltage level increases.

Test input

The control includes a TEST input connector that can be used for various testing functions during installation and service. The TEST input connector is shown in Figure 22. Table 45 summarizes the behavior of the control when the two TEST pins are connected. More detailed descriptions of the various functions are included in other sections of this document.

Table 46: TEST input functionality without Y

Duration of connection (s)	Control behavior with thermostat signals not present
< 2	No response
2 to 5	The control flashes sequentially on the STATUS LED the series of stored error codes (up to the last five since active error codes were last cleared) starting with the most recent. If there are no error codes stored in memory, the STATUS LED flashes three times (0.1 s ON / 0.1 s OFF).
> 5	The control immediately clears the stored error code array, resets the 6 h PS timer and flashes the STATUS LED six times (0.1 s ON / 0.1 s OFF) to indicate that the error memory is clear.

Figure 21: Heat pump flow diagram

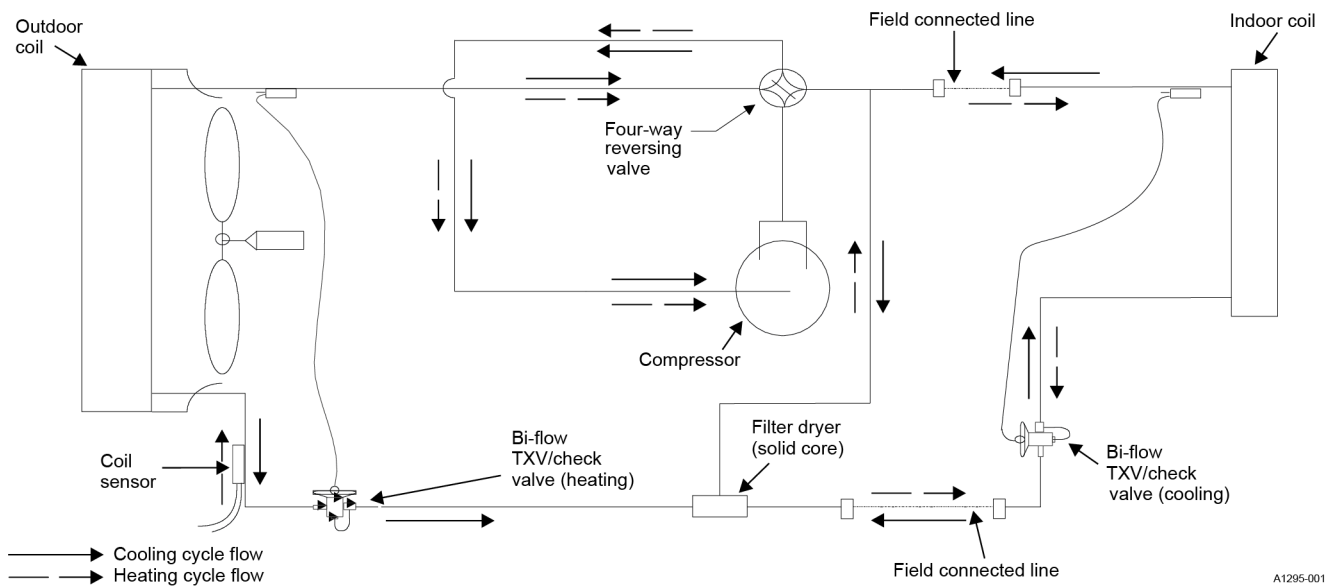

A1295-001

Figure 22: Demand defrost control module

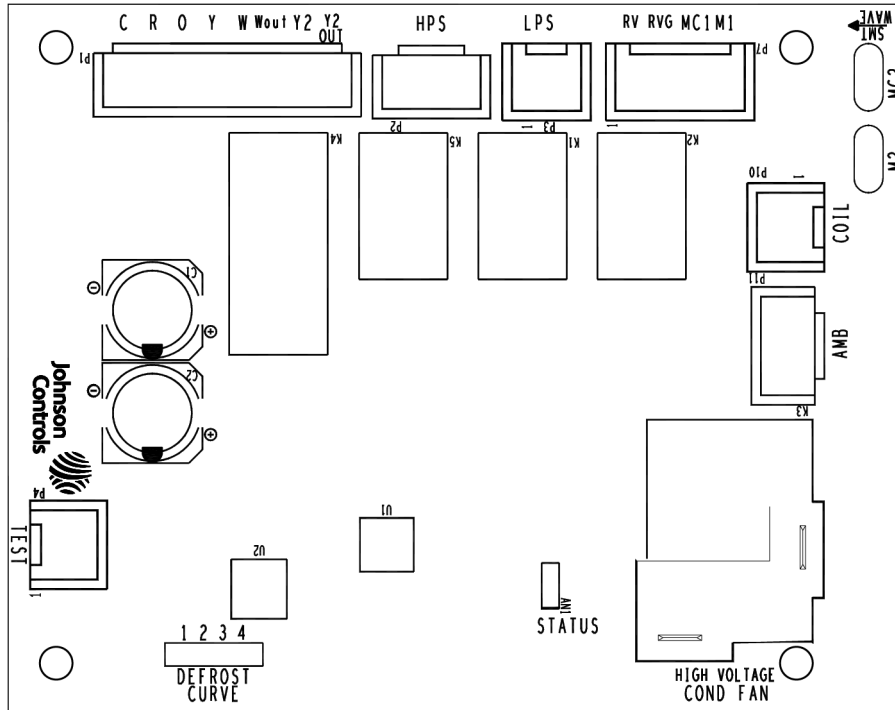

A1747-001

Fault code display

The control shall provide status codes using the LED. Status codes indicate the state of operation of the unit but do not represent a fault. The table below describes the LED displayed during status codes. Status codes will not be displayed when a fault code is present.

Table 47: Status code display

No power to the control	No faults active Nothing energized	OFF
Compressor operation active	No faults active M energized	ON
Control normal operation - no call for compressor	No faults active Y not present	2 s ON/2 s OFF
Control normal operation - in ASCD period	No faults active, Y present, ASCD timer not expired	0.1 s ON/0.1 s OFF

The control shall provide fault codes using the Status LED. Table 48 describes the LED displays during fault codes. Unless otherwise specified, the control shall provide flashes that are a 1/3 s on and 1/3 s off for fault codes. The control shall only display a single fault code on the LED. The control shall display the fault code on the LED repeatedly with a 2 s off period between repetitions of the fault code. If multiple fault codes are present at the same time, the LED shall display only the most recent fault.

Table 48 shows the number of flashes for the specified code. For instance, a flash code entry of 3 indicates that the control energizes the output for three 1/3 s on, 1/3 s

off flashes, waits 2 s, then energizes the output for three more 1/3 s on, 1/3 s off flashes and repeats.

Table 48: Faults

Description	STATUS LED
High-pressure switch fault (not in lockout yet)	2 Flashes
System in high-pressure switch lockout (last mode of operation was normal compressor)	3 Flashes
System in high-pressure switch lockout (last mode of operation was defrost)	4 Flashes
System in low-pressure switch lockout (last mode of operation was normal compressor)	5 Flashes
Low voltage (<19.2 VAC) preventing further relay outputs for > 2 s	6 Flashes
Low voltage (<16 VAC) stopped current relay outputs for > 2 s	7 Flashes
Coil sensor failure (open or shorted) - Comp. allowed/lockout	8 Flashes
Outdoor ambient sensor failure (open or shorted) - Compressor allowed if coil is > 32°F	9 Flashes
Control failure	10 Flashes

Table 48: Faults

Description	STATUS LED
W and O signal received at the same time	11 Flashes
Y2 signal received without a Y	12 Flashes

Demand defrost

The control maintains proper airflow through the outdoor coil during heating operation by melting frost and ice that may form on the coil. Frost may accumulate unevenly in different sections of the coil because of the arrangement of the refrigeration circuit within the coil. The control may initiate a defrost cycle even when the coil is not completely covered with frost. This is normal operation.

The control regulates the defrost operation of the heat pump based on accumulated compressor runtime, outdoor coil temperature, and outdoor ambient temperature. The control causes the heat pump unit to operate in the normal heating mode until it determines that a defrost cycle is needed.

Operation

The defrost mode is equivalent to the cooling mode except that the outdoor fan motor is de-energized and the Wout terminal is energized. The control must do the following to initiate a defrost cycle:

- Energize high indoor airflow through the Y2 out terminal.
- Energize high compressor speed through the M2 terminal (if not already in second stage).
- De-energize the outdoor fan.
- Energize the reversing valve.
- Energize the auxiliary heat output through the Wout terminal.
- Begin the maximum defrost cycle length timer.

If the call for heating (Y) is removed from the control during the defrost cycle, it terminates the defrost cycle and de-energize the compressor. The control also stops the defrost cycle length timer but does not reset it. When the control receives another call for heating, it restarts the defrost cycle and the timer at the point at which the call for heating was removed. This happens only if the coil sensor temperature conditions allow defrost to occur.

Defrost curves

The control uses a set of defrost curve parameters that are selected using the defrost curve selection jumper. The location of the defrost curve selection jumper is shown in the *Tabular Data Sheet* or Table 49 for each heat pump model.

Defrost curve selection

The second page of the *Tabular Data Sheet* or Table 49 indicates the correct jumper setting for the specific heat pump model.

The control only reads the jumper input when the Y and W thermostat inputs are de-energized. If a jumper position is changed while either of these inputs is energized, the control does not act upon the jumper changes until the

thermostat calls are de-energized or power (24 VAC) to the control is cycled.

Table 49: Defrost jumper pin settings

Outdoor unit	18	24	30	36	42	48	60
Defrost jumper pin setting	2	2	2	2	2	2	2

Defrost cycle initiation

The control allows the heat pump to operate in the heating mode until the combination of outdoor ambient and outdoor coil temperatures indicate that a defrost cycle is necessary.

The control initiates a defrost cycle when the coil temperature is below the initiate point for the measured ambient temperature continuously for 4 1/2 min. See Figure 23. This delay eliminates unnecessary defrost cycles caused by refrigeration surges such as those that occur at the start of a heating cycle.

The control initiates a defrost cycle every 6 h (accumulated compressor runtime) to recirculate refrigerant lubricants. This forced defrost timer resets and restarts following the completion or termination of a defrost cycle.

The control initiates a defrost cycle when the Defrost Inhibit Time Limit elapses if the previous defrost cycle was terminated based on the Maximum Defrost Cycle Time. This occurs regardless of the liquid line (coil) temperature reading. The coil does not have to be cold for the unit to be forced into defrost. When the defrost cycle begins, the control follows the normal defrost cycle routine.

The control also initiates a defrost cycle when the TEST terminals are shorted. This feature allows an installer or service technician to start a defrost cycle immediately as required. When the TEST terminals are shorted for more than 5 s with a Y input energized and the pressure switch input is closed, the ASCD is bypassed, the reversing valve is energized, the ODF is de-energized, and the compressor and the Wout terminal to auxiliary heat are energized.

When the TEST inputs are used to force a defrost cycle, the control ignores the state of the coil temperature and outdoor ambient temperature inputs. The coil does not have to be within a certain range for the heat pump to be forced into a defrost cycle. After the TEST input jumper is removed, the defrost mode terminates as normal. The defrost cycle length timer does not start until the TEST input is removed. If the TEST terminals remain shorted, the control keeps the unit in defrost mode.

Defrost inhibition

The control does not initiate a defrost cycle if the liquid line temperature is above 32°F (40°F for curve 4), unless the defrost cycle is forced using the TEST input, or the previous defrost exited on the maximum time of 14 min.

The control also prevents a defrost cycle from being initiated too soon after the initiation of the previous defrost cycle. When power is applied to the control and after the completion or termination of each defrost cycle, the control starts a 40 min timer. When this timer expires,

the control allows another defrost cycle when needed. The timer is based on accumulated compressor runtime.

Defrost termination

The control terminates the defrost cycle immediately after the liquid line temperature reaches the terminate temperature or after 14 min of defrost operation. See Figure 23.

The control does the following to terminate a defrost cycle:

- Energize the outdoor fan.
- De-energize the reversing valve.
- De-energize the auxiliary heat output through the W out terminal.
- Reset and restart the 40 min defrost inhibit timer.

Figure 23: Defrost operation curves

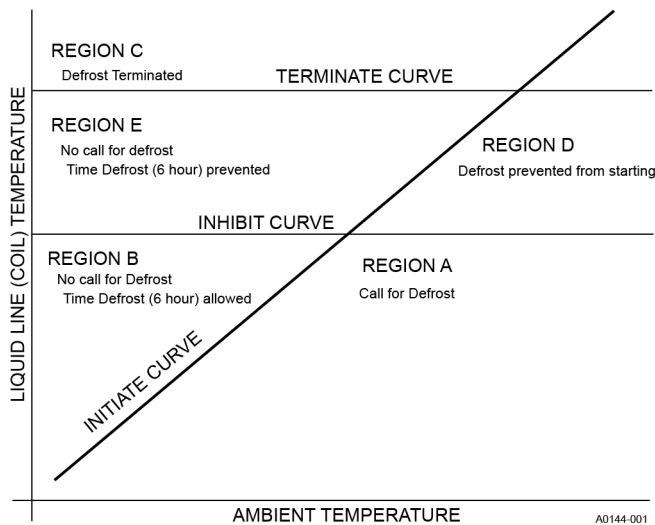

Cooling operation

During cooling operation, the control receives thermostat signals at the Y (Y + Y2 for 2nd stage), and O input terminals. The control energizes the M (M + M2 for 2nd stage) compressor output terminal. This signal energizes the coil of the compressor contactor causing the compressor to operate. The control also delivers power to the COND FAN terminals causing the outdoor fan to operate. The control energizes the REV VALVE terminal with 24 VAC to switch the reversing valve.

Heating operation

During normal heating mode, the control receives a thermostat signal at the Y (Y + Y2 for 2nd stage) input terminal. The control energizes the M (M + M2 for 2nd stage) compressor output terminal. This signal energizes the coil of the compressor contactor causing the compressor to operate. The control also delivers power to the COND FAN terminals causing the outdoor fan to operate. The reversing valve is not energized in heating mode.

In low ambient conditions (<40°F) the control energizes M2 and Y2 out, forcing second stage operation for the remainder of the call.

Emergency heat

When the thermostat calls for emergency heat operation (W signal without a Y signal), the control energizes the Wout terminal immediately.

Pressure switch fault and lockout

The heat pump is equipped with a high pressure switch and low pressure switch that connect to the control at the pressure switch terminals. If the high pressure switch input opens for more than 40 ms, the control de-energizes the compressor. If the switch is closed and a thermostat call for compressor operation is present, the control applies the 5 min anti-short-cycle delay timer and starts the compressor when the timer expires.

If the low pressure switch opens for 5 s under conditions when the control is not ignoring the low pressure switch input, the control will enter a low pressure switch fault. The control ignores the low pressure switch input during the following conditions:

- Defrost operation
- The first 120 s of compressor operation
- 120 s following the completion of a defrost cycle
- When the outdoor ambient temperature is below 5 °F

When the compressor starts following a switch fault, the control starts a 6 h timer based on accumulated compressor runtime. If the control senses another opening of the switch before the timer expires, it causes a soft lockout condition. The second opening of the switch must be greater than 160 ms for the lockout to occur. If the second opening is between 40 ms and 160 ms, the control de-energizes the compressor but does not cause a soft lockout condition. If the control does not sense a second switch opening before the 6 h timer expires, the timer and counter reset.

During the soft lockout mode, the control de-energizes the compressor and energizes the LED output with the appropriate flash code.

The control resets the soft lockout condition when any of the following occur after removal of the fault condition:

- Power is cycled to the R or Y inputs of the control. This causes the soft lockout condition to be reset when the thermostat is satisfied or when the thermostat is set to SYSTEM OFF and back to HEAT or COOL mode.
- The TEST terminals short for more than 2 s.

When the soft lockout condition is reset, the control stops displaying the fault code and responds to thermostat inputs normally.

Instructing the owner

Assist the owner with processing warranty cards or online registration. Review the *User's Information Manual*, and provide a copy to the owner and guidance on correct operation and maintenance. Instruct the owner or the operator how to start, stop, and adjust the temperature setting.

When applicable, instruct the owner that the compressor is equipped with a crankcase heater to prevent the migration of refrigerant to the compressor during the

OFF cycle. The heater is energized only when the unit is not operating. If the main switch is disconnected for long periods of shut down, do not attempt to start the unit until 8 h after the switch has been connected. This allows sufficient time for all liquid refrigerant to be driven out of the compressor.

The installer must also instruct the owner on correct operation and maintenance of all other system components.

Maintenance

- Dirt must not accumulate on the outdoor coils or other parts in the air circuit. Clean as often as necessary to keep the unit clean. Use a brush, vacuum cleaner attachment, or other suitable means.
- The outdoor fan motor bearings are permanently lubricated and do not require periodic oiling.
- If the coil needs to be cleaned, it must be washed with water or with Nu-Calgon Cal-Green (or equivalent). If using coil cleaner, follow the directions included with it. Rinse thoroughly with clean water after use. Do not use a high pressure power washer on the coil or fin damage may occur.
- Refer to the furnace or air handler *Installation Manual* for filter and blower motor maintenance.
- The indoor coil and drain pan must be inspected and cleaned regularly to prevent odors and ensure adequate drainage.



CAUTION

It is unlawful to knowingly vent, release or discharge refrigerant into the open air during repair, service, maintenance, or the final disposal of this unit.

Wiring diagrams

Example:

Figure 24: Single-phase

LEGEND

AS - AMBIENT SENSOR
 CAP - CAPACITOR
 CC - CONTACTOR COIL
 CCH - CRANKCASE HEATER
 HPS - HIGH PRESS SWITCH
 HS - HEATER SWITCH
 CS - COIL SENSOR
 LPS - LOW PRESS SWITCH
 RV - REVERSING VALVE
 SC - START CAPACITOR
 SR - START RELAY

COLOR CODE

BLK - BLACK
 BLK/PNK - BLACK w/PINK STRIPE
 BLU - BLUE
 BRN - BROWN
 GRN - GREEN
 GRY - GREY
 ORG - ORANGE
 PNK - PINK
 PUR - PURPLE
 RED - RED
 WHT - WHITE
 WHT/BRN - WHITE w/
 BROWN STRIPE
 YEL/BLK - YELLOW w/ BLACK STRIPE
 YEL/RED - YELLOW w/ RED STRIPE
 YEL - YELLOW

DANGER - SHOCK HAZARD

TURN OFF ELECTRICAL POWER BEFORE SERVICING TO PREVENT POSSIBLE DAMAGE TO THE EQUIPMENT AND POSSIBLE PERSONAL INJURY.

CAUTION

TO PREVENT ELECTRICAL SHOCK OPEN REMOTE DISCONNECT SO ELECTRICAL SUPPLY TO HEAT PUMP IS SHUT OFF.

- 1 COMPONENTS SHOWN IN DASH LINES ARE OPTIONAL.
- 2 DUAL CAPACITOR SHOWN. SEPARATE CAPACITORS MAY BE USED ON ACTUAL UNIT.
- 3 WIRING MUST CONFORM TO NATIONAL AND LOCAL CODES.
- 4 IF ANY OF THE ORIGINAL WIRE SUPPLIED WITH THIS UNIT MUST BE REPLACED, IT MUST BE REPLACED WITH 105° C THERMOPLASTIC OR ITS EQUIVALENT.
- 5 WHERE POWER SUPPLY HAS ONE (1) 230 VOLT CONDUCTOR AND ONE (1) NEUTRAL CONDUCTOR, CONNECT L2 OF CONTACTOR TO NEUTRAL.

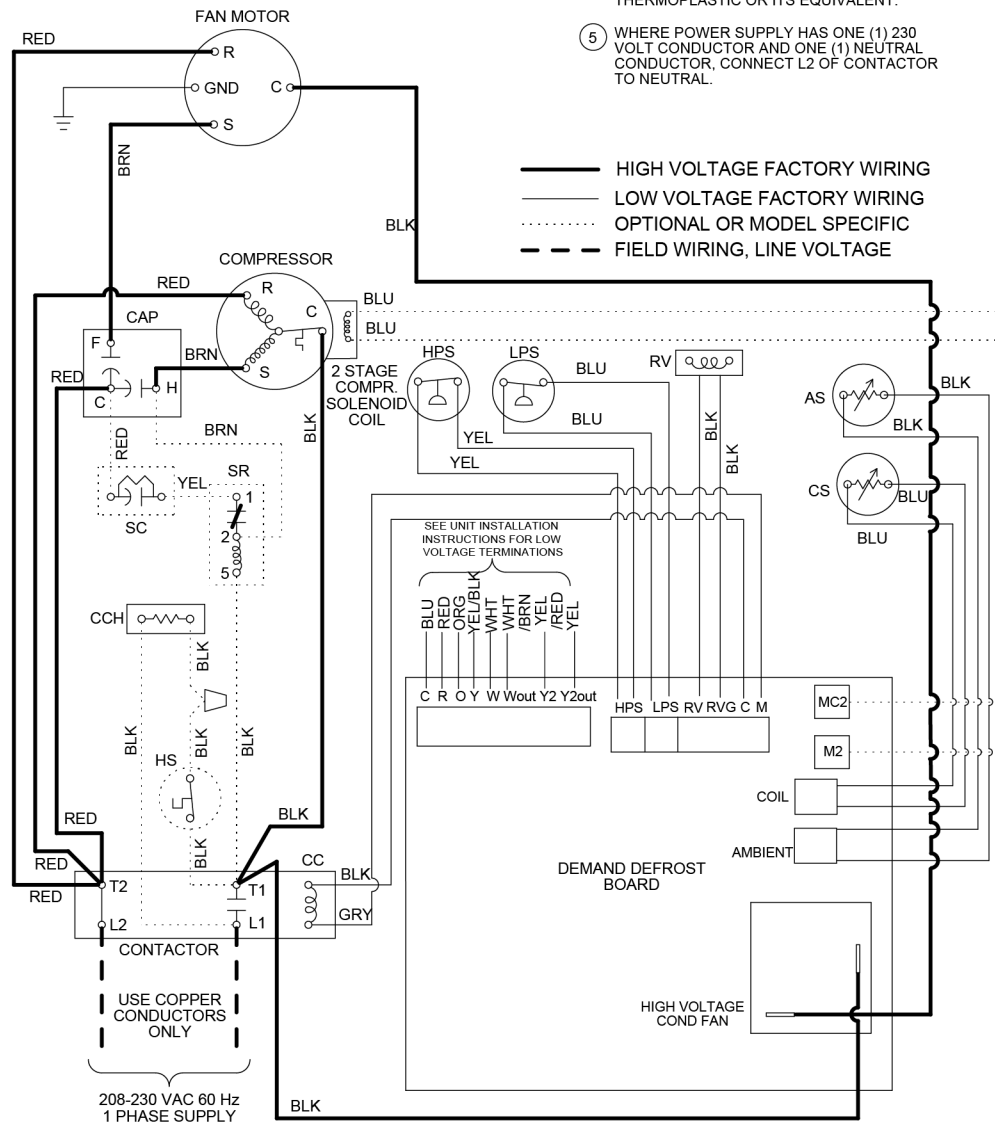

6198120-UWD-A-0122

Figure 25: Three-phase 208/230V

LEGEND

AS - AMBIENT SENSOR
 CAP - CAPACITOR
 CC - CONTACTOR COIL
 CCH - CRANKCASE HEATER
 HPS - HIGH PRESSURE SWITCH
 HS - HEATER SWITCH
 CS - COIL SENSOR
 LPS - LOW PRESSURE SWITCH
 RV - REVERSING VALVE
 FRS - FAN RELAY SWITCH

COLOR CODE

BLK - BLACK
 BLU - BLUE
 BRN - BROWN
 GRN - GREEN
 GRY - GREY
 ORG - ORANGE
 PNK - PINK
 PUR - PURPLE
 RED - RED
 WHT - WHITE
 WHT/BRN - WHITE w/
 BROWN STRIPE
 YEL/RED - YELLOW w/
 RED STRIPE
 YEL/BLK - YELLOW w/
 BLACK STRIPE
 YEL - YELLOW

CAUTION - SHOCK HAZARD

TURN OFF ELECTRICAL POWER BEFORE SERVICING TO PREVENT POSSIBLE DAMAGE TO THE EQUIPMENT AND POSSIBLE PERSONAL INJURY.

CAUTION

TO PREVENT ELECTRICAL SHOCK OPEN REMOTE DISCONNECT SO ELECTRICAL SUPPLY TO HEAT PUMP IS SHUT OFF.

① COMPONENTS SHOWN IN DASH LINES ARE OPTIONAL.

② WIRING MUST CONFORM TO NATIONAL AND LOCAL CODES.

③ IF ANY OF THE ORIGINAL WIRE SUPPLIED WITH THIS UNIT MUST BE REPLACED, IT MUST BE REPLACED WITH 105° C THERMOPLASTIC OR ITS EQUIVALENT.

— HIGH VOLTAGE FACTORY WIRING
 — LOW VOLTAGE FACTORY WIRING
 OPTIONAL OR MODEL SPECIFIC
 - - - FIELD WIRING, LINE VOLTAGE

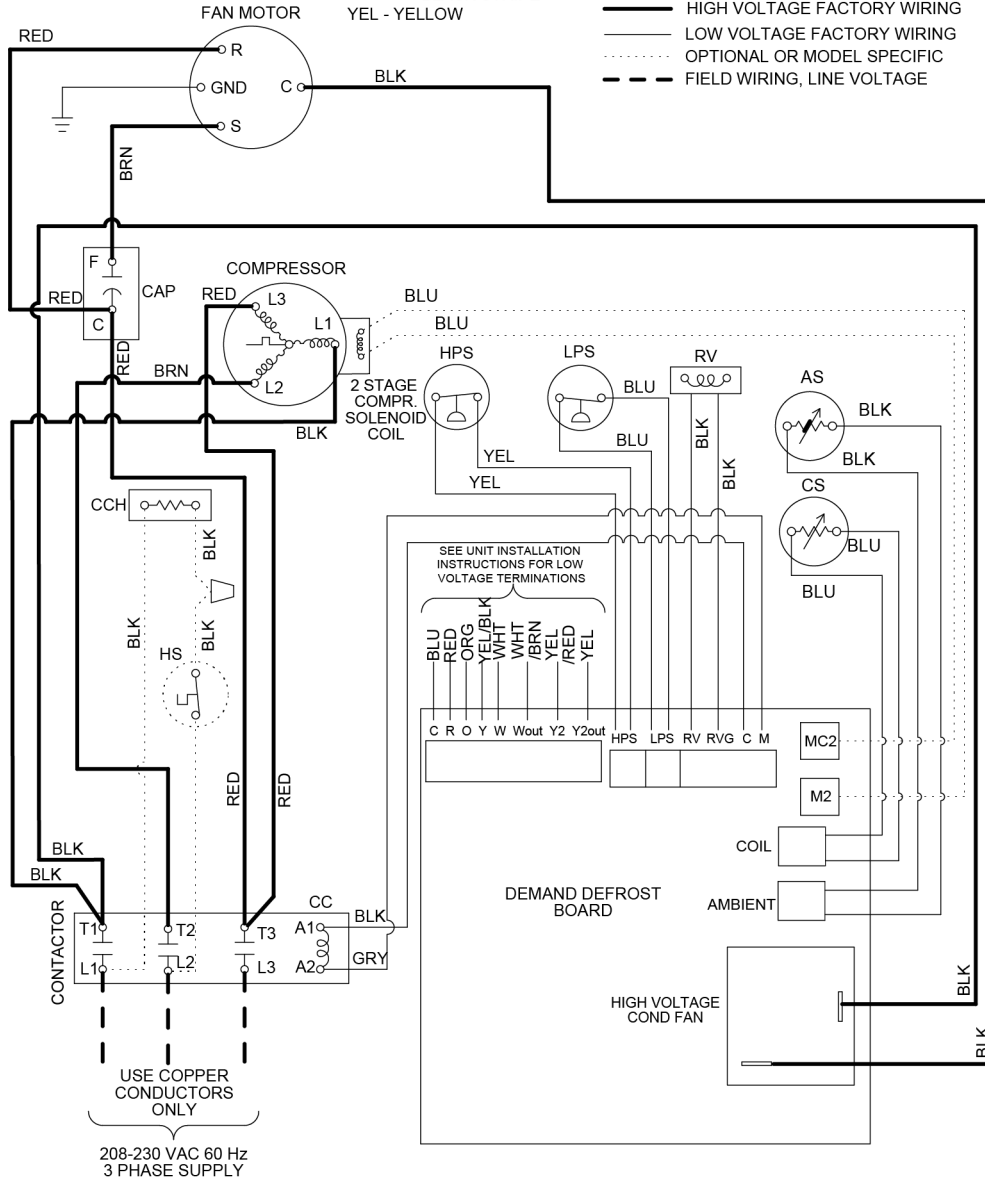

Figure 26: Three-phase 460V

LEGEND

AS - AMBIENT SENSOR
 CAP - CAPACITOR
 CC - CONTACTOR COIL
 CCH - CRANKCASE HEATER
 HPS - HIGH PRESSURE SWITCH
 HS - HEATER SWITCH
 CS - COIL SENSOR
 LPS - LOW PRESSURE SWITCH
 RV - REVERSING VALVE
 FRS - FAN RELAY SWITCH

COLOR CODE

BLK - BLACK
 BLK/WHT - BLACK w/
 WHITE STRIPE
 BLU - BLUE
 BRN - BROWN
 GRN - GREEN
 GRY - GREY
 ORG - ORANGE
 PNK - PINK
 PUR - PURPLE
 RED - RED
 WHT - WHITE
 WHT/BRN - WHITE w/
 BROWN STRIPE
 YEL/BLK - YELLOW w/
 BLACK STRIPE
 YEL/RED - YELLOW w/
 RED STRIPE
 YEL - YELLOW

DANGER - SHOCK HAZARD

TURN OFF ELECTRICAL POWER BEFORE SERVICING TO PREVENT POSSIBLE DAMAGE TO THE EQUIPMENT AND POSSIBLE PERSONAL INJURY.

CAUTION

TO PREVENT ELECTRICAL SHOCK OPEN REMOTE DISCONNECT SO ELECTRICAL SUPPLY TO HEAT PUMP IS SHUT OFF.

① COMPONENTS SHOWN IN DASH LINES ARE OPTIONAL.

② WIRING MUST CONFORM TO NATIONAL AND LOCAL CODES.

③ IF ANY OF THE ORIGINAL WIRE SUPPLIED WITH THIS UNIT MUST BE REPLACED, IT MUST BE REPLACED WITH 105° C THERMOPLASTIC OR ITS EQUIVALENT.

— HIGH VOLTAGE FACTORY WIRING
 — LOW VOLTAGE FACTORY WIRING
 OPTIONAL OR MODEL SPECIFIC
 - - - - FIELD WIRING, LINE VOLTAGE

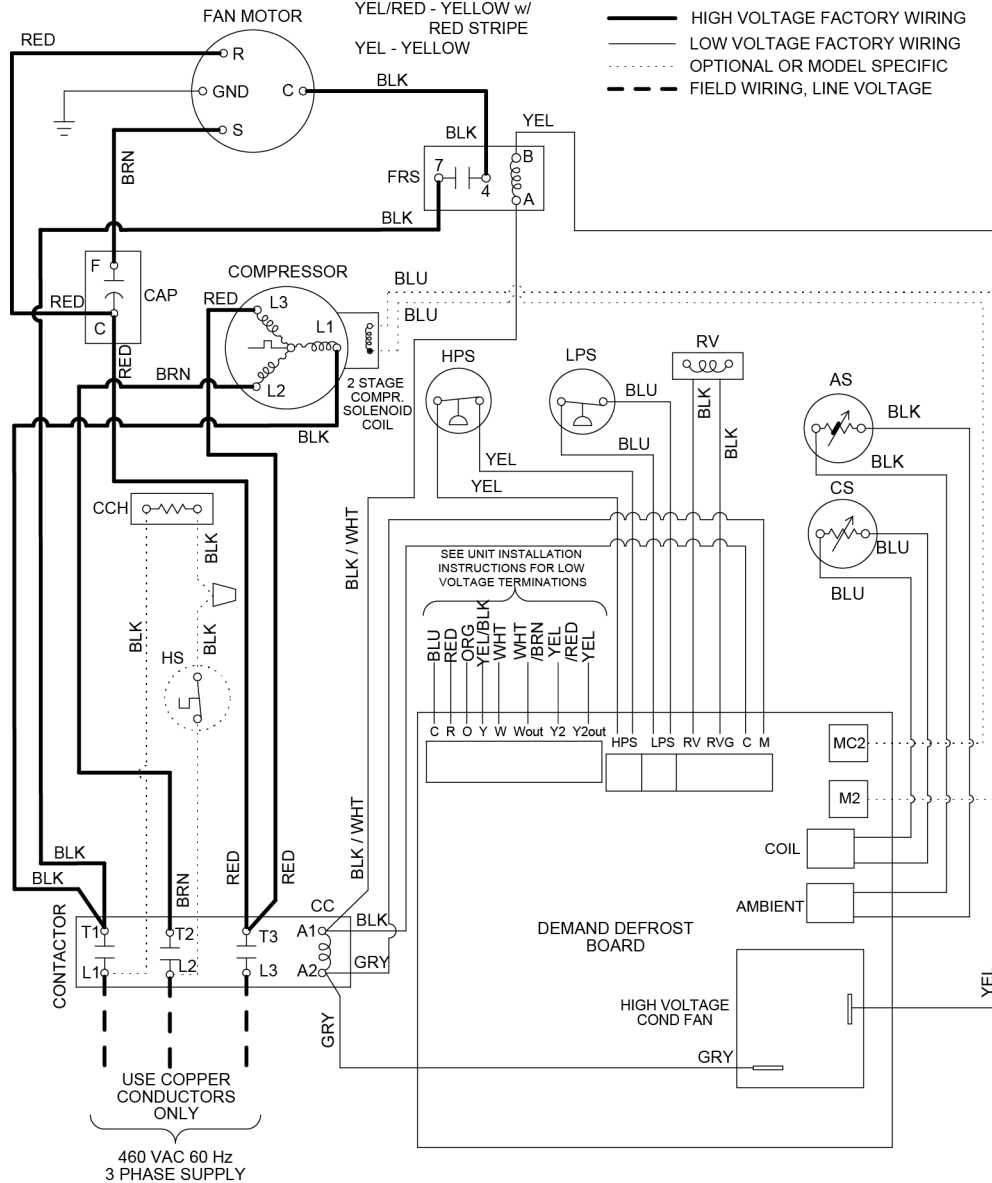

Start-up sheet

Example:

Heat Pump and Supplementary Heat Start-up Sheet

Correct start-up is critical to customer comfort and equipment longevity

Start-up date

Technician performing start-up Installing contractor name

Owner information

Name Address

City State or province Zip or postal code

Equipment data Upflow Downflow Horizontal left Horizontal right

Indoor unit model no. Indoor unit serial no.

Indoor coil model no. Indoor coil serial no.

Outdoor unit model no. Outdoor unit serial no.

Filter, thermostat, and accessories

Filter type Filter size Filter locations

Thermostat type Other system equipment and accessories

Connections in accordance with installation instructions and local codes

Unit is level Supply plenum and return ducts are connected and sealed Refrigerant piping complete and leak-tested

Gas piping is connected (if applicable) Vent system is connected (if applicable)

Condensate drain for indoor coil correctly connected Condensate drain for furnace (if applicable)

Electrical: line voltage

Indoor unit (VAC) Outdoor unit (VAC) Overcurrent protection breaker/fuses (A)

Ground wire is connected Polarity is correct (120 VAC indoor units), black is L1 (hot), white is N (neutral)

Electrical: low voltage Thermostat wiring complete Heat anticipator is set to the recommended value listed in the installation instructions

Low voltage values: R and C at indoor unit control board (VAC)

R and C at outdoor unit control board (VAC) Heat anticipator recommended value

Supplementary heating set-up

Heating type: Electric air handler Natural gas LP gas (requires LP conversion kit)

Inlet gas pressure (in. W.C.) Manifold gas pressure (in. W.C.) LP gas conversion kit part no. used

Calculated input in Btu/h - clock the gas meter (natural gas only) LP kit installed by

Electric heat kit part no. (if applicable) kW installed Rated Btu/h (furnaces)

Venting (if applicable) Venting system correctly sized within the limitations of the charts in the installation instructions

Intake size No. of 90° elbows No. of 45° elbows Length

Exhaust size No. of 90° elbows No. of 45° elbows Length

Air side: system total external static pressure

Supply static before indoor coil (in. W.C.) <input style="width:80%;" type="text"/>	Supply static after indoor coil (in. W.C.) <input style="width:80%;" type="text"/>
Return static (in. W.C.) before filter <input style="width:80%;" type="text"/>	Return static (in. W.C.) after filter (furnace side) <input style="width:80%;" type="text"/>
Total external static pressure (ESP) <input style="width:80%;" type="text"/>	Maximum rated ESP (in. W.C.) <input style="width:80%;" type="text"/>

Airflow setup

Blower type and set-up	Variable speed ECM <small>(circle 0 or 1)</small>	Heat	0 / 1	0 / 1			
		Low cool	0 / 1	0 / 1	0 / 1		
		High cool	0 / 1	0 / 1	0 / 1		
		Delay	0 / 1	0 / 1			
		Stage 1 kW	0 / 1	0 / 1			
		Heat kit selection	0 / 1	0 / 1	0 / 1	0 / 1	
	Standard ECM	HP heating/cooling	<input type="radio"/> 1	<input type="radio"/> 2	<input type="radio"/> 3	<input type="radio"/> 4	<input type="radio"/> 5
		Electric heat speed	<input type="radio"/> 1	<input type="radio"/> 2	<input type="radio"/> 3	<input type="radio"/> 4	<input type="radio"/> 5
		Continuous fan speed	<input type="radio"/> 1	<input type="radio"/> 2	<input type="radio"/> 3	<input type="radio"/> 4	<input type="radio"/> 5

Supply static (in. W.C.) <input style="width:80%;" type="text"/>	Supply air dry bulb temperature <input style="width:80%;" type="text"/>	Outside air dry bulb temperature <input style="width:80%;" type="text"/>
Return static (in. W.C.) <input style="width:80%;" type="text"/>	Return air dry bulb temperature <input style="width:80%;" type="text"/>	Return air wet bulb temperature <input style="width:80%;" type="text"/>
Total external static pressure <input style="width:80%;" type="text"/>	Temperature drop <input style="width:80%;" type="text"/>	Supply air wet bulb temperature <input style="width:80%;" type="text"/>

Defrost control board

Fill in ON, OFF, or the appropriate value for the fields that apply to the installed defrost control board.

Two stage
 Demand defrost
 Variable capacity
 Time and temperature

Low temperature cut out
 Balance point
 Defrost curve
 Y2 lock
 FFUEL
 Switch point

Hot heat pump
 Bonnet sensor present
 Runtime (time and temperature board): only 30 min, 60 min, or 90 min

Refrigerant charge and metering device

R-410A
 TXV
 Fixed orifice

Additional refrigeration piping length
 Adder per lb-ft oz

No. of elbows
 No. of 45s
 Total added: lb oz

Orifice size
 Suction line temperature (°F)
 High side pressure
 Low side pressure

TXV No.
 Liquid line temperature (°F)
 Subcooling
 Superheat

Cycle test

- Operate the unit through several heating cycles from the thermostat, noting and correcting any problems.
- Operate the unit through continuous fan cycles from the thermostat, noting and correcting any problems.
- Operate the unit through a cooling cycle, noting and correcting any problems.
- Operate the unit through an emergency heating cycle, noting and correcting any problems.

Clean up

- Installation debris disposed of, and indoor and outdoor areas cleaned up

Owner education

- Provide the owner with the owner's manual.
- Explain operation of the system to the owner.
- Explain thermostat use and programming (if applicable) to the owner.
- Explain the importance of regular filter replacement and equipment maintenance.

Comments section

Subject to change without notice. Published in U.S.A. Copyright © 2022 by Johnson Controls. All rights reserved.